

# AluGlobe

DISTRIBUCIJA ALUMINIJUMSKIH, PVC PROFILA I PRATEĆE OPREME

by **ALUROLL**

## IZBOR IZ PROIZVODNOG PROGRAMA **ALUMINCO**<sup>®</sup> ALUMINIUM BUILDING SYSTEMS SA CENOVNIKOM ARTIKALA



# AluGlobe.

## DISTRIBUCIJA ALUMINIJUMSKIH, PVC PROFILA I PRATEĆE OPREME



Sigurno se poznajemo!

ALUGLOBE, iako nedavno osnovanu PJ, čini odabrani tim koji je već dokazao svoj kvalitet prethodnim zajedničkim radom, odgovornošću i poslovnim uspesima.

Mi hoćemo baš Vas za poslovnog partnera!

Klijenta koji, kao i mi, zna šta hoće. Zato Vas pozivamo da nas posetite, jer su Vam vrata naše firme uvek otvorena.

DOBRODOŠLI !

OSNOVANO 1978  
**ALUROLL**  
*...for smart people*



certifikovan  
sistem kvaliteta  
prema  
ISO 9001:2008

TRGOVINSKO-PROIZVODNO d.o.o.  
Karađorđeva 36, 34227 Batočina

[www.aluglobe.com](http://www.aluglobe.com)  
[info@aluglobe.com](mailto:info@aluglobe.com)

Matični broj: 07626967  
Poreski broj PIB: 101220521  
Šifra delatnosti: 051700  
Žiro račun: 265-3310310001439-08

**PJ AluGlobe.**, Batajnički drum 6-O, 11080 Zemun  
Tel: 011/6555-685, 6555686 Fax: 011/6555-688



## DISTRIBUCIJA ALUMINIJUMSKIH, PVC PROFILA I PRATEĆE OPREME

### Sadržaj:

|  |    |
|--|----|
| Cenovnik profila sistema za građevinarstvo<br>(prozori i vrata).....                         | 03 |
| Kategorije boja .....  | 04 |
| Opisi sa sertifikatima .....   | 05 |
| Komparacija serija Aluminco sa drugim<br>proizvođačima profila .....                         | 13 |
| Spisak profila po serijama na stanju u<br>Aluglobe magacinima .....                          | 14 |
| Sistemi za kapije i ograde .....   | 17 |
| Sistemi staklenih ograda .....   | 30 |
| Sistemi pergola .....  | 48 |
| Dekoratívni paneli za vrata .....  | 65 |
| Protiv-požarna vrata.....  | 83 |
| Metalna vrata.....   | 85 |
| Fotonaponski paneli sa podkonstrukcijom<br>na ravnim i kosim krovovima i ravnim poljima..... | 86 |

## CENOVNIK ALUMINIJUMSKIH PROFILA ALUMINCO

Cenovnik važi od 01.06.2013 do izdavanja novog

| PROFILI BEZ TERMIČKOG<br>PREKIDA- HLADNI | VP cene     | Primer cene sa popustom<br>(20%) i PDV-om (20%) |
|--|-------------|---|
| SIROVI                                   | 3.98 EUR/kg | 3.82 EUR/kg                                     |
| ELOKSIRANI E0                            | 5.31 EUR/kg | 5.10 EUR/kg                                     |
| KATEGORIJA A (BELO/BRAON...)             | 4.46 EUR/kg | 4.28 EUR/kg                                     |
| KATEGORIJA B                             | 4.92 EUR/kg | 4.72 EUR/kg                                     |
| KATEGORIJA C                             | 5.08 EUR/kg | 4.88 EUR/kg                                     |
| KATEGORIJA D                             | 5.18 EUR/kg | 4.97 EUR/kg                                     |
| KATEGORIJA E                             | 5.62 EUR/kg | 5.40 EUR/kg                                     |
| KATEGORIJA WOOD                          | 8.35 EUR/kg | 8.02 EUR/kg                                     |
| PROFILI SA TERMIČKIM<br>PREKIDOM -TERMO  | VP cene     | Primer cene sa popustom<br>(20%) i PDV-om (20%) |
| SIROVI                                   | 4.76 EUR/kg | 4.57 EUR/kg                                     |
| ELOKSIRANI E0                            | 6.09 EUR/kg | 5.84 EUR/kg                                     |
| KATEGORIJA A (BELO/BRAON...)             | 5.24 EUR/kg | 5.03 EUR/kg                                     |
| KATEGORIJA B                             | 5.70 EUR/kg | 5.47 EUR/kg                                     |
| KATEGORIJA C                             | 5.85 EUR/kg | 5.62 EUR/kg                                     |
| KATEGORIJA D                             | 5.96 EUR/kg | 5.72 EUR/kg                                     |
| KATEGORIJA E                             | 6.40 EUR/kg | 6.14 EUR/kg                                     |
| KATEGORIJA WOOD                          | 9.13 EUR/kg | 8.76 EUR/kg                                     |

- VELEPRODAJNE CENE (VP) IZRAŽENE SU U EUR/kg, **BEZ PDV-a i BEZ RABATA**
- PLAĆANJE SE VRŠI U DINARIMA PO SREDNJEM KURSU NARODNE BANKE SRBIJE
- KATEGORIJE PLASTIFIKACIJE (A-E), SU U NASTAVKU CENOVNIKA
- NA CENE SISTEMA ZA KAPIJE, OGRADE, PERGOLE I DEKORATIVNE PANELE ODOBRAVAMO POPUST OD 20%

Category -A

•8014 9003 9005 9010 9016

Category -B

•1013 1015 1019 5002 5005 5008 5010 5014 5017 6003  
•6005 6009 7001 7004 7011 7012 7015 7016 7021 7022  
•7024 7031 7035 7037 7038 7040 7043 8002 8011 8017  
•8019

Category -C

•1014 1020 3005 3007 3009 3012 3014 3015 5000 5001  
•5003 5004 5007 5009 5011 5012 5013 5015 5018 5019  
•5020 5021 5022 5023 5024 6000 6004 6006 6007 6008  
•6011 6012 6013 6014 6015 6019 6020 6021 6022 6024  
•6025 6026 6028 6029 6033 6034 7000 7002 7003 7005  
•7006 7007 7008 7009 7010 7013 7023 7026 7030 2703  
•7033 7034 7036 7039 7042 7044 7045 7046 7047 8000  
•8001 8003 8004 8007 8008 8012 8015 8016 8022 8023  
•8024 8025 8028 9001 9902 9011 9017 9018  
•MAT COLORS : 1013, 1015, 5014, 6005, 6009, 7038, 8014, 8017

Category -D

•1000 1001 1007 1017 1021 1024 1027 1033 3003 3011 3033 1031  
4002 6002 6016 6017 6018 7048 9006 9007  
•MAT COLORS:3005, 5010, 7009, 7016 ,7030, 7034, 7040

Category -E

•AKZO FUTURA COLLECTION  
•NEOKEM MESOGEIOS & SAHARA COLLECTION  
•1035 1036 2004 3004 4012 9006 FUTURA 9022 9023  
•MAT SABLE FIJI

WOOD COLORS

## KATEGORIJE PLASTIFIKACIJE ALUMINIJUMSKIH PROFILA ALUMINCO

## AL410 Opening

Hladno-krilni sistem  
 Öffnungssysteme

 The reliable solution indicated for replacements of old frames of small dimensions. It combines flexibility and economy in fabrication with high aesthetics and perfect functionality.

 Pouzdano rešenje indikovano za zamene starih otvora malih dimenzija. Kombinuje fleksibilnost i ekonomičnost u izradi visoke estetike i savršene funkcionalnosti.

 Diese zuverlässige Lösung bietet sich zum Ersatz von alten Türen mit kleinen Maßen an. Sie kombiniert Flexibilität und Bauwirtschaftlichkeit mit geschmackvollem Entwurf und ausgezeichneter Funktionalität.

### Svojstva sistema

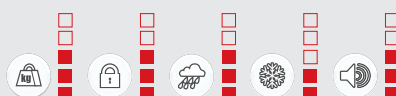

### Tehničke karakteristike

|                        |        |
|------------------------|--------|
| Širina krila           | 41mm   |
| Širina najmanjeg krila | 41mm   |
| Zastakljenje do        | 37,8mm |



## AL510 Opening

Krilno-hladni sistem  
 Öffnungssysteme

 One of the timeless opening systems in the market. The harmonious flat and curved design, offers perfect aesthetics and significant performance for new buildings or restorations of wide openings.

 Jedan od najpopularnijih hladno-krilnih sistema na tržištu. Harmoničan i zaobljen dizajn, pruža savršenu estetiku i značajan učinak za nove objekte ili za restauraciju širokih otvora.

 Gehört zu den nachhaltigsten Öffnungssystemen auf dem Markt. Der harmonische Entwurf dieser Produktreihe mit flachen und geschwungenen Linien, bietet eine geschmackvolle Ästhetik und hohe Leistungsfähigkeit für neue Konstruktionen oder bei Renovierungen von großen Bauöffnungen.

### Svojstva sistema

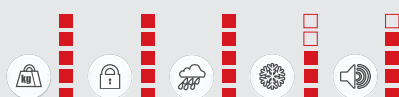

### Tehničke karakteristike

|                       |      |
|-----------------------|------|
| Širina krila          | 57mm |
| Najmanja širina krila | 50mm |
| Zastakljenje do       | 37mm |



## AL450 Thermal Opening

Termo izolaciono krilni sistem  
Wärmedämmende Öffnungssysteme

 With its careful design the ideal quality-cost relation is achieved in thermal break frames. AL450 is an integrated system of medium and small fabrications offering solutions for all typologies.

 Sa svojim pažljivim dizajnom idealan odnos kvalitet-troškovi je postignut u termo izolacionom okviru. AL450 je integrisani sistem srednjih i malih konstrukcija koji nudi rešenja za sve tipologije.

 Der hochwertige Entwurf gewährt ein ideales Preis-Leistungsverhältnis der wärmedämmenden Tür - bzw - Fenstereinrichtungen. Bei AL450 handelt es sich um ein ausgereiftes System für mittlere und kleinere Konstruktionen und eine vielseitige Lösung in allen angebotenen Typen.

## AL450 Termo izolacioni sa poliamidom 24mm, CE ili PVC Groove Mehanizmom (Multi-point Locking)

 A thermal break system of high performance for small and medium fabrications. Its modern design offers several functional options. It is suitable for the construction of all types of opening frames.

The wide range of profiles covers multiple architecture applications and offers a wide range of fabrication options. One may choose different colors for inside and outside. Due to its careful design it gives the best value for money ratio in the thermal break frames section.

A high quality and performance thermal break system ensuring optimum protection through the use of the multiple c locks that can be adjusted.

 Termo izolacioni sistem visokih performansi za male i srednje konstrukcije. Moderan dizajn nudi nekoliko funkcionalnih mogućnosti. Pogodan je za sve vrste krilnih konstrukcija.

Širok rang profila obuhvata više arhitektonskih aplikacija i nudi širok spektar proizvodnih opcija. Mogu se izabrati različite nijanse iznutra i spolja. Zbog svog dizajna daje najbolju vrednost za novac u termo izolacionom sektoru. Visok kvalitet i performanse termo izolacionog sistema koji obezbeđuje optimalnu zaštitu kroz korišćenje perimetričkog okova.

 Ein Wärmedämmungs-System hoher Leistung für mittlere und kleinere Konstruktionen. Sein modernes Design und großes Profilingebot bieten zahlreiche funktionsfähige Optionen, erfüllen mehrere architektonische und Bau-Anwendungen und ist deshalb für den Aufbau jeder Rahmenöffnung geeignet. Dazu kann man, verschiedene Farben für die Innen- und Außen-Profile wählen.

Dank des funktionellen Entwurfs, entsteht ein ideales Preis-Leistungsverhältnis. Ein hochqualitativ und Hochleistungs Wärmedämmungs-System, das durch die Verwendung mehrere perimetrische Schließpunkte optimal schützt.

### Svojstva sistema

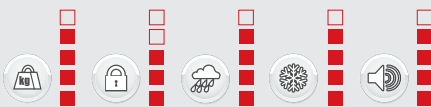

### Tehničke karakteristike

|                           |      |
|---------------------------|------|
| Širina krila              | 70mm |
| Širina najmanjeg štoka    | 62mm |
| Zastakljivanje do         | 52mm |
| Poliamid Nemačkog porekla | 24mm |

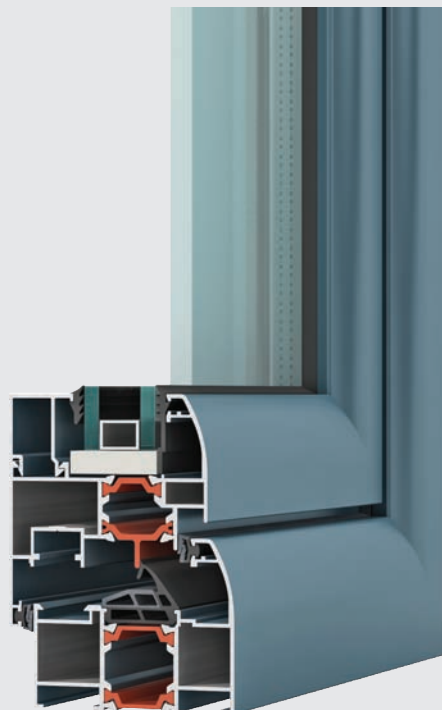
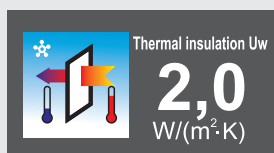



## AL520 Thermal Opening

Termo izolaciono krilni sistem  
Wärmedämmende Öffnungssysteme

### Termo izolacioni sa poliamidom 24mm, CE (Eurožleb) Mehanizmom

 The ideal thermal break system for wide openings. Available in a variety of profiles meeting multiple architectural applications and suitable for building restorations or new constructions.

 Idealan termo izolacioni sistem za velike otvore. Dostupan u raznim profilima koji zadovoljavaju više arhitektonskih aplikacija i pogodan za restauracije ili nove konstrukcije.

 Das ideale Wärmedämmungssystem für Konstruktionen mit großen Gebäudeöffnungen. Verfügbar in einer Vielfalt von Profilbreiten, geeignet für jeden architektonischen Entwurf, sowohl für Renovierungen als auch für Neubauten.

## AL550 Termo izolacioni sa poliamidom 24mm, PVC Groove Mehanizmom (Multi-point Locking)

 A unique combination of modern design with several functional values. A thermal break system of high performance for demanding fabrications, offering the absolute security by means of a perimeter locking.

It has waterproof and airtight foamy EPDM rubbers for absolute impermeability. There is a wide range of profiles that cover multiple architectural applications and give the option of multiple fabrication options. The system is available in various colors, inside and outside.

 Jedinstvena kombinacija modernog dizajna sa nekoliko funkcionalnih vrednosti. Termo izolacioni sistem visokih vrednosti. Termo izolacioni sistem visokih vrednosti. Termo izolacioni sistem visokih vrednosti. Nudi apsolutnu sigurnost perimetrijskog zaključavanja. Ima vodootporne i hermetičko penaste EPDM gume za apsolutnu nepropustljivost. Ima širok rang profila koji zadovoljavaju više arhitektonskih aplikacija i daju mogućnost za više konstrukcijskih opcija. Sistem je dostupan u raznim nijansama, i dvobojno.

 Eine einzigartige Kombination moderner Design mit hoher Funktionalität. Ein Wärmedämmungs-System hoher Leistung für anspruchsvolle Konstruktionen, dass absolute Sicherheit durch einen perimetrischen Schließmechanismus bietet. Die schaumig EPDM-Gummidichtung sorgt für absolute Undurchlässigkeit. Es gibt ein großes Profilingangebot, das mehrere architektonische Anwendungen und Bau-Optionen erfüllt. Dazu bietet dieses System die Möglichkeit unterschiedlichen innen -und außen- Profilarben.

#### Svojstva sistema

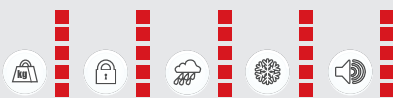

#### Tehničke karakteristike

|                           |      |
|---------------------------|------|
| Širina krila              | 73mm |
| Širina najmanjeg krila    | 65mm |
| Zastakljivanje do         | 52mm |
| Poliamid Nemačkog porekla | 24mm |

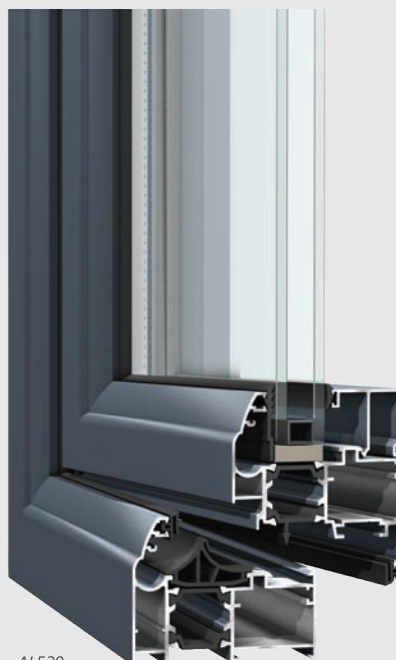
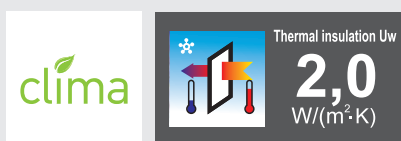

AL520  
CE (Eurožleb)



AL550 PVC žleb



## AL570 Dynamic Thermal Opening

Termo izolaciono krilni sistem  
Wärmedämmende Öffnungssysteme

Spearhead technology in absolute insulation and energy saving. A unique combination of high performance and thermal break with 24mm polyamides. Multi-point locking system and high level thermal and sound insulation guarantee perfect quality, functionality and considerable energy saving.

Tehnologija apsolutne izolacije i uštede energije. Jedinstvena kombinacija visokih performansi i termo izolacije sa poliamidima od 24mm. Multi point sistem zaključavanja i visok nivo zvučne i termo izolacije garantuju savršen kvalitet, funkcionalnost i značajnu uštedu energije.

Der aktuellste technische Stand in der optimalen Dämmung und Energieeffizienz. Eine einzigartige, leistungsstarke Kombination und Wärmedämmung mit 24mm Polyamid. Die maximale Sicherheit mit vielzähligen Schlosseinrichtungen und das hohe Niveau an Wärme- und Schalldämmung gewährleisten optimale Qualität, Funktionalität und Energieeffizienz.

## AL570 Dynamic PLUS Thermal Opening

An innovative with high specifications thermal insulating opening frame that due to its increased thermal insulating qualities it is ideal for areas where extreme weather conditions exist. Thanks to its profile thickness and its 34mm polyamide it is suitable for all kinds of wide openings. The thermo insulating frame AL570 dynamic plus combines utilitarian design with aesthetic quality, providing a number of possible solutions due to the 34mm width of its polyamide and its unlimited number of profiles that cover multiple fabrications. A superior quality and performance thermal break system ensuring optimum protection due to its multiple locks.

Inovativan sa visokim specifikacijama termo izolacionog sistema, koji je zbog povećanih termo izolacionih kvaliteta idealan za oblasti sa ekstremnim vremenskim uslovima. Zahvaljujući debljini profila i poliamidu od 34mm pogodan je za sve vrste velikih otvora. Termo izolacija AL570 dynamic plus kombinuje jedinstveni dizajn sa estetskim kvalitetom, pružajući veliki broj mogućih rešenja zbog poliamida od 34mm i neograničen broj profila koji pokrivaju razne konstrukcije. Vrhunski kvalitet i performanse termo izolacionog sistema obezbeđuje optimalnu zaštitu sa perimetričkim okovom.

Ein innovatives Wärmedämmungs-System mit hohen Spezifikationen, das aufgrund seiner erhöhten wärmedämmenden Eigenschaften, ideal für Bereiche in denen extreme Klimabedingungen bestehen geeignet ist. Dank seiner Profilstärke und sein 34mm Polyamid, ist es für alle Öffnungsarten geeignet. Der Thermoisolierend Rahmen AL570 Dynamic Plus kombiniert utilitaristisches Design mit ästhetischer Qualität und bietet eine Anzahl von möglichen Lösungen aufgrund der 34mm Breite seines Polyamid und seine umfangreiche Anzahl von Profilen. Außer der überlegenen Qualität und Systemleistung, gewährleistet es optimalen Schutz dank seines perimetrischen Schließmechanismus.

### Svojstva sistema

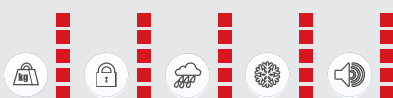

### Tehničke karakteristike

|                           | Dynamic | Dynamic PLUS |
|---------------------------|---------|--------------|
| Širina krila              | 85mm    | 95mm         |
| Najmanja širina krila     | 77mm    | 94,5mm       |
| Zastakljivanje do         | 42mm    | 52mm         |
| Poliamid Nemačkog porekla | 24mm    | 34mm         |

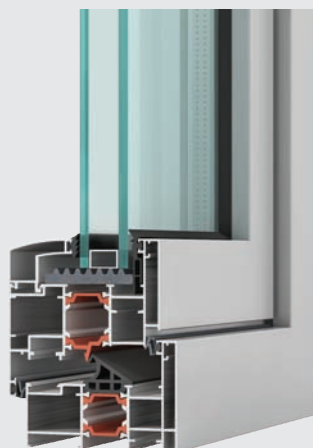

AL570 Dynamic

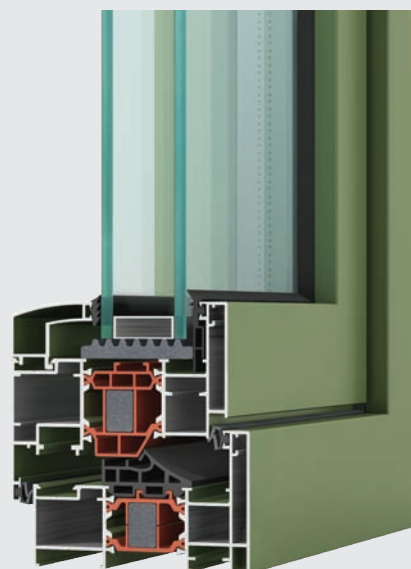

AL570 Dynamic PLUS

## AL590 Main Entrance Door

Sistem ulaznih vrata  
Wärmedämmende Öffnungssysteme

🇬🇧 A robust thermal break system, simply designed, appropriate for main entrance applications in business and residential buildings. It can receive (optional) special locking reinforcement for burglary resistance abilities in accordance with WK2 certification.

🇷🇸 Robustan termo izolacioni sistem, jednostavno dizajniran, pogodan za primenu ulaznih sistema u poslovne i stambene zgrade. Može da primi (opciono) posebno pojačanje za blokiranje mogućnosti provala u skladu sa WK2 sertifikatom.

🇩🇪 Ein robustes Wärmedämmungssystem mit stilvollem Entwurf, geeignet als Haupteingang für berufliche und private Räume. Kann mit speziell verstärkten Schlossvorrichtungen ausgestattet werden, um gemäß der Zertifizierung Wk2, einbruchssichere Eigenschaften aufzuweisen.



- With glazing up to 59mm
- Zastakljenje do 59mm
- Mit Verglasung bis 95mm

### Svojstva sistema

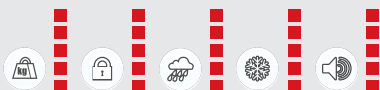

### Tehničke karakteristike

|                           |           |
|---------------------------|-----------|
| Širina krila              | 65 & 73mm |
| Najmanja širina krila     | 65 & 73mm |
| Zastakljenje do           | 59mm      |
| Poliamid Nemačkog porekla | 16 & 24mm |



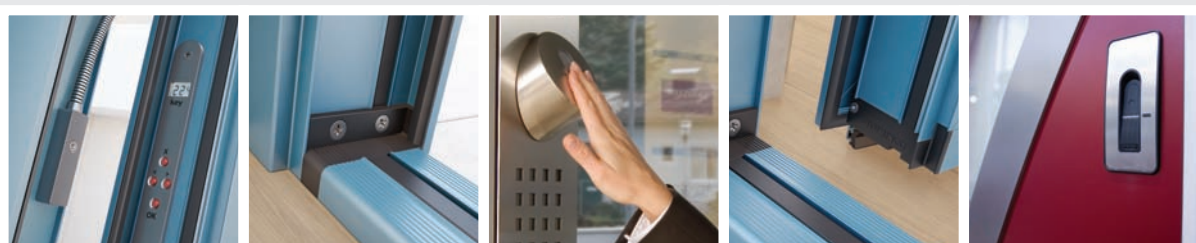
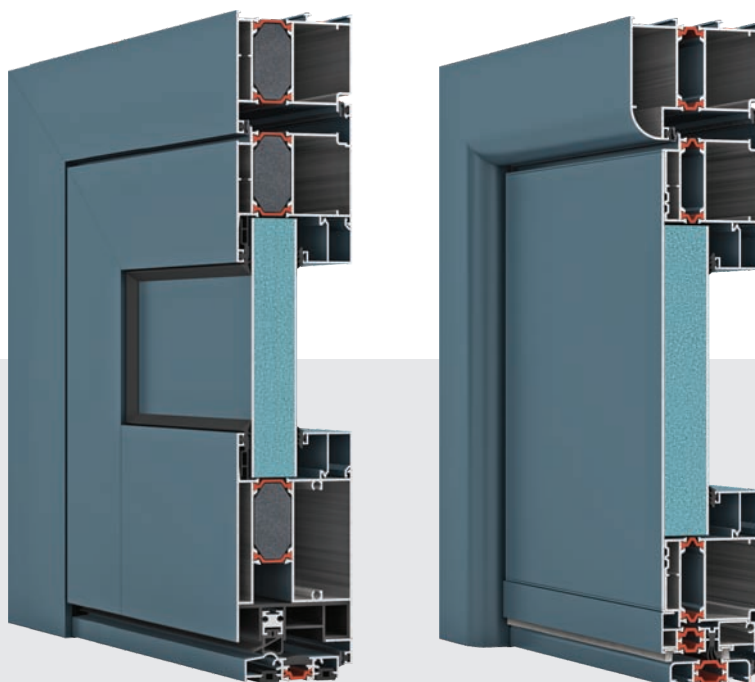

|  |  |  |   |  |  |
|--|--|--|---|--|--|
|  | Thermal insulation U <sub>w</sub><br><b>1,8</b><br>W/(m <sup>2</sup> ·K) |  | Burglar protection<br><b>2,0</b><br>DIN EN 1627 |  | Sound proof insulation<br><b>R<sub>w</sub> 31 dB</b> |
|--|--|--|---|--|--|



## AL220 Thermal Sliding

Klizni termo izolacioni sistem  
Wärmedämmende Schiebesysteme

 Exceptionally flexible sliding thermal break system for extreme weather conditions. Its elevating and sliding mechanism makes it easy to use, while it can carry up to 200kg weight of glass.

 Izuzetno fleksibilan klizni termo izolacioni sistem za ekstremne vremenske uslove. Njegov podizno-klizni mehanizam olakšava korišćenje istog, a može da ponese do 200kg težine stakla i krila.

 Besonders flexibles wärmedämmendes Schiebesystem bei außerordentlichen Klimabedingungen. Der Hebe- und Schiebemechanismus ist nutzerfreundlich und kann mit Verglasung bis zu einem Gewicht von 200kg ausgestattet werden.

### Svojstva sistema

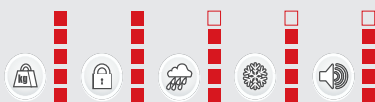

### Tehničke karakteristike

|  |                     |
|--|---------------------|
| Širina krila                                   | 45mm                |
| Dim.troduple vodjice<br>Staklo-Komarnik-grilje | ↓ 48,9mm<br>↔ 115mm |
| Poliamid Nemačkog<br>porekla                   | 32mm                |

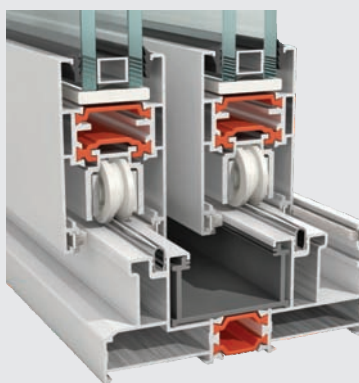

Detail of double overlapping door.

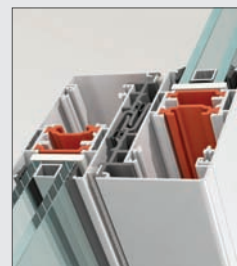

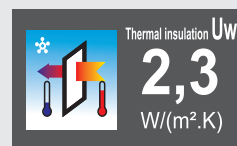

clima



## AL230 Sliding

Klizni sistem  
Schiebesysteme

 An innovative smooth and quiet sliding system. Its modern design meets all architectural requirements combining wide openings and easy fabrication.

 Inovativni gladak i tih klizni sistem. Njegov moderan dizajn ispunjava sve zahteve arhitekture, kombinujući velike otvore i jednostavnu montazu.

 Ein innovatives Schiebe-System, das für eine laufruhige und geräuschlose Bewegung sorgt. Das moderne Design trifft jede architektonische Anforderung und kombiniert große Öffnungen mit Baubehaglichkeit.

### Svojstva sistema

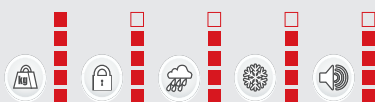

### Tehničke karakteristike

|   |                     |
|---|---------------------|
| Širina krila  | 37,6mm              |
| Dimenzije duple preklopne<br>vodjice                | ↓ 35mm<br>↔ 95,61mm |
| Ugradne dimenzije vodjice<br>Staklo-komarnik-grilje | ↓ 35mm<br>↔ 130mm   |
| Zastakljenje do                                     | 25mm                |







Harmonika sistem  
Falttürsystem

## PA460 Folding Door

Harmonika sistem  
Falttürsystem

 A folding door system with modern specifications well made design and top of the line quality. Designed and developed to cover all wide openings both in residential and professional constructions. All panels can be stockpiled in one end of the opening occupying the less possible space. Ideal for the construction of a transparent shell, which binds harmonically the internal and external spaces of a building.

 Harmonika sistem vrata sa modernim dizajnom, odličnim specifikacijama i savršenom kvalitetnom linijom. Dizajniran i razvijen da pokrije sve velike otvore kako u stambenim tako i u poslovnim prostorima. Svi paneli mogu biti skupljeni u jednom kraju otvora da bi zauzeli što je moguće manje prostora. Idealan za transparentne otvore, koji harmonično vezuju unutrašnji i spoljni prostor.

 Ein Falttürsystem von einer hochwertigen Qualität mit modernen Spezifikationen und Design. Gedacht und entwickelt um Lösungen für alle weiten Fensteröffnungen sowohl bei Wohn-als auch professionellen Konstruktionen zu bieten. Alle Panels können auf einer Seite der Öffnung gestellt werden damit weniger Raum benötigt ist. Ideal für den Aufbau einer transparenten Bauhülle, die harmonisch die interne undexterne Räume eines Gebäudes bindet.

# AluGlobe.

**ALUMINCO**  
ALUMINIUM-PROFILSYSTEME

Folding Systems

### Svojstva sistema

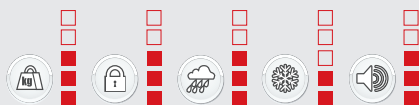

### Tehničke karakteristike

|                          |             |
|--------------------------|-------------|
| Širina krila             | 46mm        |
| Širina štoka             | 45,4-54,5mm |
| Debljina zastakljenja    | 18-36mm     |
| Maksimalna težina stakla | 60 kg       |

Aluglobe  
katalog sa  
cenovnikom  
2013

11



## POREDJENJE SERIJA PROIZVODJAČA ALUMINIJUMSKIH SISTEMA

| ALUMINCO           | ALUMIL | ELVIAL          |
|--------------------|--------|-----------------|
| AI410              | M940   | el-4500         |
| AI510              | M9400  | el-2000         |
| AI450              | M9650  | el-2200         |
| AI520              | M11000 | el-5200/el-4400 |
| AI570              | M11500 | el-5700         |
| AI570 DYNAMIC PLUS | M11600 | el-5700         |
| PA460              | M9800  | el-8200         |
| AI590              | SD95   | el-8000         |
| AI230              | M9200  | el-3300         |
| AL220              | M300   | el-6700         |

PROFILI I PRATEĆI PRIBOR PO SERIJAMA NA STANJU U MAGACINU ALUGLOBE

| PROFIL  | OPIS PROFILA                      | AL 510                                | HLADNI PROFILI            | DODATNO                           |
|---------|-----------------------------------|---------------------------------------|---------------------------|-----------------------------------|
|         |                                   | SPOJNICE NA INBUS                     | SPOJNICE NA STIPANJE      |                                   |
| 510 109 | ŠTOK OBLI RUSTIKA                 | EA510 149U                            | EA510 199UA (G U)         | EA 410 205 / INOX                 |
| 540 103 | ŠTOK OBLI                         | EA410 124U                            | EA510 192UA (G U)         | EA 410 205 / INOX                 |
| 510 101 | ŠTOK RAVANI                       | EA410 124U                            | EA510 192UA (G U)         | EA 410 205 / INOX                 |
| 510 102 | ŠTOK SA BALONOM RUSTIKA           | EA410 124U                            | EA510 192UA (G U)         | EA 410 205 / INOX                 |
| 510 213 | KRILO VRATA SP.OTVARANJE RUSTIKA  | EA510 148U + EA510 155UA              |                           | EA 410 205 + EA 410 216 / INOX    |
| 510 201 | KRILO PROZORA RUSTIKA             | EA410 124U                            | EA510 189SA               | EA 410 205 + EA 410 216 / INOX    |
| 510 210 | KRILO VRATA RUSTIKA               | EA410 124U + EA510 155UA              | EA510 168UA               | EA 410 205 + EA 410 216 / INOX    |
| 540 202 | KRILO PROZORA                     | EA410 124U + EA510 156UA              | EA510 170UA               | EA410 205/INOX + EA3000 851 / PVC |
| 540 203 | KRILO VRATA                       | EA410 124U + EA510 154U / EA510 184SA | EA510 168UA / EA510 184SA | EA410 205/INOX + EA3000 851 / PVC |
| 510 503 | ŠLOGA OBLO RAVNA                  |                                       |                           | PVC CEP EA510 866M                |
| 510 501 | ŠLOGA RAVNA                       |                                       |                           | PVC CEP EA510 851M                |
| 510 402 | PARAPET                           |                                       |                           |                                   |
| 510 301 | " T " PROFIL                      |                                       |                           |                                   |
| 510 302 | " T " PROFIL                      |                                       |                           |                                   |
| 510 907 | OKAPNICA                          |                                       |                           | PVC CEP EA410 833M                |
| 510 802 | PERVAJZ                           |                                       |                           | EA 410 205 / INOX                 |
| 510 806 | PERVAJZ                           |                                       |                           | EA 410 205 / INOX                 |
| 510 915 | SKRETNICA 90°                     |                                       |                           |                                   |
| 510 921 | SKRETNICA 90°                     |                                       |                           |                                   |
| 019 025 | CEV Ø60                           |                                       |                           |                                   |
| 510 601 | PRIHVATNIK CEVI                   |                                       |                           | GUMA EA410 411M                   |
| 510 905 | PRAG                              |                                       |                           |                                   |
| 510 904 | ADAPTER ZA KRILO                  |                                       |                           |                                   |
| 510 913 | ADAPTER ZA PARAPET                |                                       |                           |                                   |
| 410 803 | SPOJ DVA ŠTOKA                    |                                       |                           |                                   |
| 420 721 | LAJSNA STAKLA OBLA / LUFT 28.8mm  |                                       |                           | MEDALION EA410 880A               |
| 420 722 | LAJSNA STAKLA RAVNA / LUFT 28.8mm |                                       |                           |                                   |
| 510 714 | LAJSNA STAKLA RAVNA / LUFT 12mm   |                                       |                           |                                   |
| 520 914 | SOLBANK 150mm                     |                                       |                           |                                   |
| 520 915 | SOLBANK 180mm                     |                                       |                           |                                   |
| 520 916 | SOLBANK 210mm                     |                                       |                           |                                   |

| PROFIL  | OPIS PROFILA                   | AL 410                  | HLADNI PROFILI       | DODATNO                           |
|---------|--------------------------------|-------------------------|----------------------|-----------------------------------|
|         |                                | SPOJNICE NA INBUS       | SPOJNICE NA STIPANJE |                                   |
| 410 111 | ŠTOK OBLI                      | EA410 123U              |                      | EA 410 205 / INOX                 |
| 410 102 | ŠTOK SA BALONOM RUSTIKA        | EA410 123U / EA410 122P |                      | EA 410 205 / INOX                 |
| 410 202 | KRILO PROZORA                  | EA410 123U              |                      | EA 410 205 + EA 410 216 / INOX    |
| 410 207 | KRILO VRATA SPOLJNJE OTVARANJE | EA410 123U + EA410 151  |                      | EA 410 205 + EA 410 216 / INOX    |
| 410 225 | KRILO VRATA                    | EA410 123U + EA410 151  |                      | EA410 205/INOX + EA3000 851 / PVC |
| 410 706 | LAJSNA RAVNA LUFT 26mm         |                         |                      |                                   |
| 410 704 | LAJSNA RAVNA LUFT 12mm         |                         |                      |                                   |
| 410 305 | " T " PROFIL                   |                         |                      |                                   |
| 410 304 | " T " PROFIL VEĆI              |                         |                      |                                   |
| 410 501 | ŠLOGA OBLA                     |                         |                      | PVC cep EA410 852                 |
| 410 402 | PARAPET                        |                         |                      | Guma EA410 440                    |
| 410 903 | ADAPTER PARAPRTA               |                         |                      |                                   |
| 410 907 | ADAPTER KRILA VRATA            |                         |                      | Guma EA410 440                    |
| 510 902 | PRAG                           |                         |                      | PVC guma EA410 490M2              |
| 410 905 | JOTA                           |                         |                      |                                   |

| PROFIL  | OPIS PROFILA                   | AL 520                                 | TERMO PR. PROFILI                      | DODATNO                           |
|---------|--------------------------------|--|--|-----------------------------------|
|         |                                | SPOJNICE NA INBUS                      | SPOJNICE NA STIPANJE                   |                                   |
| 520 109 | ŠTOK RUSTIKA VEĆI              | EA520 112U / EA520 178SA               | EA520 183UA (G U) / EA520 178SA        | EA 410 205 / INOX                 |
| 520 105 | ŠTOK RAVNI MALI                | EA520 112U / EA520 177SA               | EA520 183UA (G U) / EA520 177SA        | EA 410 205 / INOX                 |
| 520 108 | ŠTOK RAVNI SREDNJI             | EA520 112U / EA520 177SA               | EA520 183UA (G U) / EA520 177SA        | EA 410 205 / INOX                 |
| 520 106 | ŠTOK RAVNI VEĆI                | EA410 121P + EA520 158UA / EA520 181UA | /                                      | EA 410 205 / INOX                 |
| 520 201 | KRILO PROZORA RUSTIKA          | EA520 112U / EA520 173K                | EA520 183UA (G U) / EA520 173K         | EA410 205/INOX + EA3000 851 / PVC |
| 520 202 | KRILO VRATA MANJE RUSTIKA      | EA410 121P + EA520 185UA / EA520 173K  | EA520 180UA + EA520 185UA / EA520 173K | EA410 205/INOX + EA3000 851 / PVC |
| 520 203 | KRILO VRATA RUSTIKA            | EA520 112U + EA520 159UA / EA520 178SA | EA520 182UA / EA520 178SA              | EA410 205/INOX + EA3000 851 / PVC |
| 520 206 | KRILO VRATA SPOLJNJE OTVARANJE | EA520 112U + EA520 159UA / EA520 179SA | EA520 182UA / EA520 179SA              | EA410 205/INOX + EA3000 851 / PVC |
| 520 204 | KRILO PROZORA RAVNO            | EA520 112U / EA520 173K                | EA520 183UA (G U) / EA520 173K         | EA410 205/INOX + EA3000 851 / PVC |
| 520 205 | KRILO VRATA RAVNO              | EA520 112U + EA520 159UA / EA520 178SA | EA520 182UA / EA520 178SA              | EA410 205/INOX + EA3000 851 / PVC |
| 510 917 | ADAPTER ZA KRILO VRATA         |  |  | PVC 2EP EA510 837M                |
| 520 308 | " T " PROFIL VEĆI              |  |  |                                   |
| 520 501 | ŠLOGA RAVNA                    |  |  | PVC 2EP EA520 858M                |
| 520 502 | ŠLOGA OBLA                     |  |  | PVC 2EP EA520 859M                |
| 520 402 | PARAPET                        |  |  | Guma parapeta EA410 440           |
| 520 601 | SKRETNICA 90                   |  |  |                                   |
| 520 902 | PRAG                           |  |  |                                   |
| 510 714 | LAJSNA RAVNA LUFT 27.7mm       |  |  |                                   |
| 510 713 | LAJSNA RAVNA LUFT 31.5mm       |  |  |                                   |
| 410 706 | LAJSNA RAVNA ZA TROSLOJNO      |  |  |                                   |
| 420 724 | LAJSNA RAVNA LUFT 36.5mm       |  |  |                                   |
| 420 723 | LAJSNA OBLA LUFT 36.5mm        |  |  |                                   |

| PROFIL  | OPIS PROFILA                     | AL 450                                | TERMO PR. PROFILI             | DODATNO                                   |
|---------|----------------------------------|---------------------------------------|-------------------------------|---|
|         |                                  | SPOJNICE NA INBUS                     | SPOJNICE NA STIPANJE          |   |
| 450 101 | ŠTOK RAVNI                       | EA450 137U / EA450 167U               | EA450 165U (G U) / EA450 167U |   |
| 450 102 | ŠTOK OBLI                        | EA450 137U / EA450 136U               | EA450 165U (G U) / EA450 163U | EA 410 205 / INOX                         |
| 450 201 | KRILO PROZORA RAVNO              | ES210 121U / EA450 160B               | EA450 162U / EA450 160B       | EA450 140U (spsl2000) + EA 410 216 / INOX |
| 450 202 | KRILO PROZORA ZA OBLJENO         | ES210 121U / EA450 160B               | EA450 162U / EA450 160B       | EA450 140U (spsl2000) + EA 410 216 / INOX |
| 450 501 | ŠLOGA RAVNA                      |                                       |                               | PVC 2EP EA450 888M                        |
| 450 211 | KRILO PROZORA RAVNO " PVC "      | /                                     | EA450 161U / EA450 160U       | EA450 140U (spsl2000) + EA510 207I/U      |
| 450 212 | KRILO PROZORA ZA OBLJENO " PVC " | /                                     | EA450 161U / EA450 160U       | EA450 140U (spsl2000) + EA510 207I/U      |
| 450 511 | ŠLOGA RAVNA " PVC "              |                                       |                               | PVC 2EP EA450 889M                        |
| 450 301 | " T " PROFIL                     |                                       |                               |   |
| 570 901 | SPOJ DVA ŠTOKA                   |                                       |                               |   |
| 510 907 | OKAPNICA                         |                                       |                               | PVC 2EP EA410 833M                        |
| 510 713 | LAJSNA RAVNA ZA STAKLO 20mm      |                                       |                               |   |
| 420 724 | LAJSNA RAVNA ZA STAKLO 24mm      |                                       |                               |   |
| 420 723 | LAJSNA OBLA ZA STAKLO 24 mm      |                                       |                               |   |
| 450 903 | PROFIL PROM. SMERA OTV.          | EA450 137U / EA450 167U               | EA450 165U (G U) / EA450 167U | EA 410 205 / INOX                         |
| 450 203 | KRILO VRATA RAVNO                | EA410 121P + EA 450 180 / EA 450 170U | EA 450 172 / EA 450 170U      | EA450 140U (spsl2000) + EA410 216 (INOX)  |
| 450 204 | KRILO VRATA RAVNO SP.OTV.        | EA410 121P + EA 450 180 / EA 450 170U | EA 450 172 / EA 450 170U      | EA450 140U (spsl2000) + EA410 216 (INOX)  |
| 450 902 | PRAG                             |                                       |                               |   |
| 450 901 | DODATAK KRILA VRATA              |                                       |                               |   |



|         |                               | AL 570 Dynamic Plus     | TERMO PR. PROFILI             |                           |
|---------|-------------------------------|-------------------------|-------------------------------|---------------------------|
| PROFIL  | OPIS PROFILA                  | SPOJNICE NA INBUS       | SPOJNICE NA STIPANJE          | DODATNO                   |
| 570 142 | ŠTOK RAVNI                    | /                       | EA520 183 (G U) / EA570 195SA | EA510 207I/U              |
| 570 211 | KRILO PROZORA                 | /                       | EA570 196SA / EA570 195SA     | E3000 851M + EA510 207I/U |
| 570 511 | ŠLOGA RAVNA                   |                         |                               | PVC ČEP EA570 881M        |
| 570 342 | " T " PROFIL                  | EA570 146U / EA570 147U |                               |                           |
| 570 784 | LAJSNA OBLA RAVNA LUFT 36.4mm |                         |                               |                           |
| 570 786 | LAJSNA RAVNA LUFT 36mm        |                         |                               |                           |

|         |                                  | AL 590                               | TERMO PR. PROFILI VRATA   |                    |
|---------|----------------------------------|--------------------------------------|---------------------------|--------------------|
| PROFIL  | OPIS PROFILA                     | SPOJNICE NA INBUS                    | SPOJNICE NA STIPANJE      | DODATNO            |
| 590 101 | ŠTOK UNUTRAŠNJE OTVARANJE        | EA590 118U + 590 194UA / EA590 190SA | EA590 191UA / EA590 190SA |                    |
| 590 102 | ŠTOK SPOLJAŠNJE OTVARANJE        | EA590 118U + 590 194UA / EA590 190SA | EA590 191UA / EA590 190SA |                    |
| 590 201 | KRILO VRATA                      | EA590 118U + 590 194UA / EA590 190SA | EA590 191UA / EA590 190SA | EA 410 216 / INOX  |
| 590 202 | KRILO VRATA SPOLJAŠNJE OTVARANJE | EA590 118U + 590 194UA / EA590 190SA | EA590 191UA / EA590 190SA | EA 410 216 / INOX  |
| 590 907 | PRAG                             |                                      |                           |                    |
| 590 501 | ŠLOGA                            |                                      |                           | PVC ČEP EA590 876  |
| 590 902 | ADAPTER ZA KRILO 590 201         |                                      |                           | PVC ČEP EA590 842M |
| 590 905 | SPOJ DVA ŠTOKA                   |                                      |                           |                    |
| 590 904 | LAJSNA ADAPTER KRILA             |                                      |                           |                    |
| 590 903 | ADAPTER ZA KRILO 590 202         |                                      |                           |                    |
| 510 714 | LAJSNA RAVNA                     |                                      |                           |                    |

|         |                    | PA 460            | HLADNI PROFILI HARMONIKA |         |
|---------|--------------------|-------------------|--------------------------|---------|
| PROFIL  | OPIS PROFILA       | SPOJNICE NA INBUS | SPOJNICE NA STIPANJE     | DODATNO |
| 460 201 | KRILO              | EA410 126U        |                          |         |
| 460 121 | GORNJA ŠINA        |                   |                          |         |
| 460 101 | ŠTOK               |                   |                          |         |
| 460 901 | DONJA ŠINA         |                   |                          |         |
| 460 911 | DONJA ŠINA         |                   |                          |         |
| 460 902 | ADAPTER DONJE ŠINE |                   |                          |         |
| 460 900 | NOSAČ ČETKICE      |                   |                          |         |
| 460 301 | " T " PROFIL       |                   |                          |         |
| 460 912 | ŠLOGA              |                   |                          |         |
| 420 721 | LAJSNA OBLA        |                   |                          |         |
| 420 722 | LAJSNA RAVNA       |                   |                          |         |

|         |                            | AL 220                  | TERMO PR. PROFILI KLIZNI Ili PODIZNO KLIZNI |   |
|---------|----------------------------|-------------------------|---|---|
| PROFIL  | OPIS PROFILA               | SPOJNICE NA INBUS       | SPOJNICE NA STIPANJE                        | DODATNO   |
| 220 122 | ŠTOK DVOŠINSKI             | ES220 116U / ES220 116U |   | EA510 207I  |
| 220 132 | ŠTOK TROŠINSKI             | ES220 116U / ES220 116U |   | EA510 207I  |
| 220 201 | KRILO                      | ES220 115X              |   | ES220 226P – PVC "L" spojnice krila / EA510 207I            |
| 220 204 | KRILO SA LAJSNOM           | /                       | ES220 198SA / ES220 198SA                   | ES220 226P – PVC "L" spojnice krila / EA510 207I            |
| 220 914 | LAJSNA ZA KRILO            |                         |   |   |
| 220 305 | SUČEONI SPOJ KRILA " NOS " |                         |   | PVC ČEP ES220 872M  |
| 220 301 | ŠLOGA za krilo 220 201     |                         |   | ES3120 901 – plastika za šlogu                              |
| 220 300 | ŠLOGA                      |                         |   | ES420 443M – guma za šlogu / ES250 412M – plastika za šlogu |
| 220 903 | DODATAK ZA ŠTOK            |                         |   |   |

|         |                            | AL 230            | HLADNI PROFILI KLIZNI                |                    |
|---------|----------------------------|-------------------|--------------------------------------|--------------------|
| PROFIL  | OPIS PROFILA               | SPOJNICE NA INBUS | DODATNO                              |                    |
| 230 133 | ŠTOK TROŠINSKI             |                   |                                      |                    |
| 230 131 | ŠTOK DVOŠINSKI             | ES230 130U (KLIN) |                                      |                    |
| 230 116 | ŠTOK JEDNOŠINSKI           | ES230 130U (KLIN) |                                      |                    |
| 230 205 | KRILO KLIZNO               | ES210 120U        | PVC spojnice ES230 207P x4 kom       |                    |
| 230 304 | ŠLOGA ZA KLIZNO            |                   | PVC ČEP EA230 851M / Guma ES230 417M |                    |
| 210 501 | " H " PREČKA ZA KLIZNO     |                   |                                      |                    |
| 230 307 | SUČEONI SPOJ KRILA " NOS " |                   |                                      | PVC ČEP EA230 886M |
| 230 901 | POKRIVNA LAJSNA ZA ŠINU    |                   |                                      |                    |
| 230 902 | RUHOHVAT                   |                   |                                      | PVC ČEP EA230 844M |
| 230 903 | NOSAČ RUKOHVATA            |                   |                                      |                    |

**ALUMINCO**<sup>®</sup>  
ALUMINIUM BUILDING SYSTEMS

# Kapije i ograde



# Blind H

A variation of the main pattern made of aluminium profile in horizontal mounting. Available in a wide range of patterns and colors as well as imitation wood shades.

Varijanta glavnog ulaza od horizontalnih aluminijumskih profila. Dostupan u širokom spektru dezena i nijansi, kao i u imitaciji drveta.



GH01.02 Patterned horizontal rabote.  
Horizontalni rebrasti profil



GH12.01  
Patterned horizontal rabote with inox sleep beading and built-in anodised elements.  
Horizontalni rebrasti profil sa inox rukohvatom i ugradnim eloksiranim elementima.



GH05.01  
Patterned horizontal rabote with anodised profile.  
Horizontalni rebrasti profil sa eloksiranim profilom.



GD02.04



GD01.07



GD02.06

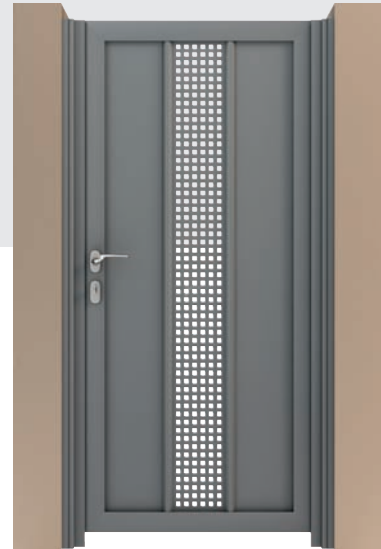

GD01.08



GD02.02



FD10.01 Fence with built transom.  
Ograda sa ugrađenom podelom.

# Tipovi

Typical constructions

Tipične konstrukcije

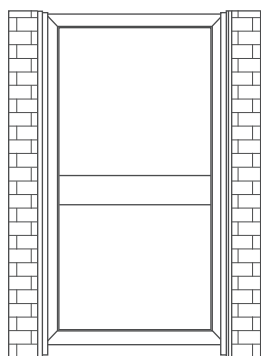

*Single sash swing gate*  
*Jednokrilna kapija*

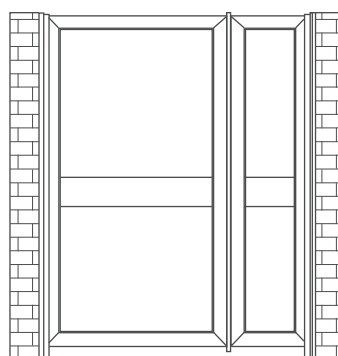

*Single sash swing with fixed element*  
*Jednokrilna kapija sa fiksnim elementom*

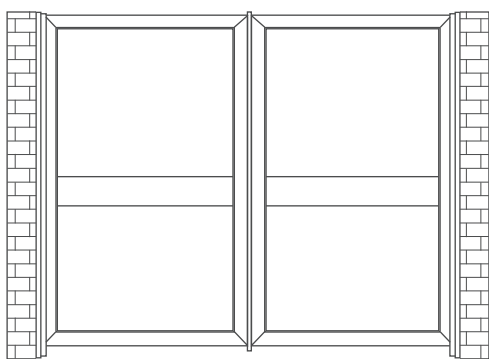

*Double sash swing gate*  
*Dvokrilna kapija*

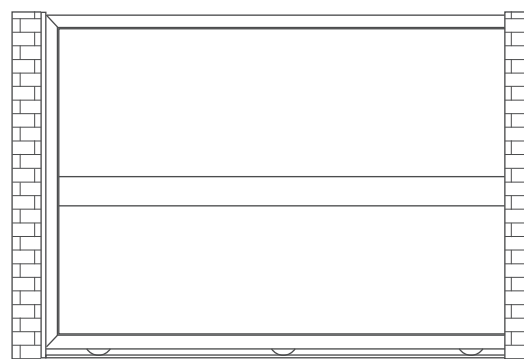

*Sliding gate*  
*Klizna kapija*

## Vertical constructions Vertikalna konstrukcija

The wide range of aluminium profiles offers many constructions possibilities for fences in vertical and horizontal arrangement. Choose among the 8 different fence designs and combine them with the respective gates.

Širok rang aluminijumskih profila nudi brojne mogućnosti za ograde u vertikalnim i horizontalnim konstrukcijama. Izbor između 8 različitih dizajna ograde i kombinovanje sa odgovarajućom kapijom.

1 Square profile 20x20mm  
Kvadratni profil 20x20mm

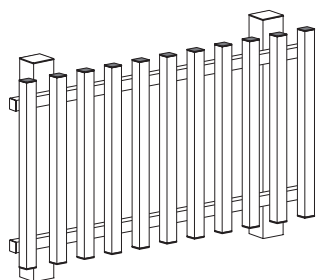

2 Rectangle rabote 60mm  
Pravougaoni rabote profil 60mm

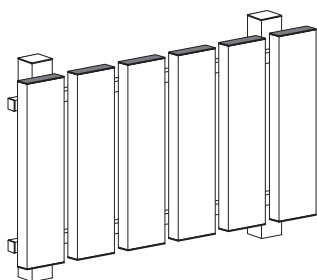

3 Curved rabote 100mm  
Zaobljen profil 100mm

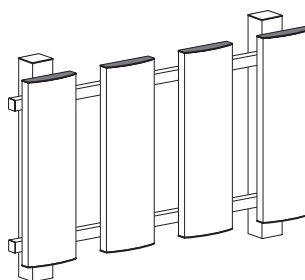

4 Patterned rabote with glass 6mm  
Rebrasti profili sa staklom od 6mm

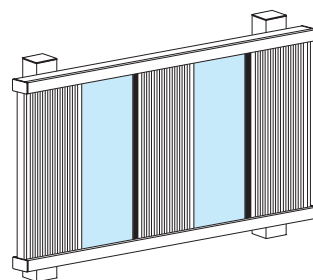

5 Patt. rabote with anodised profile  
Rebrasti profili sa eloks. profilima

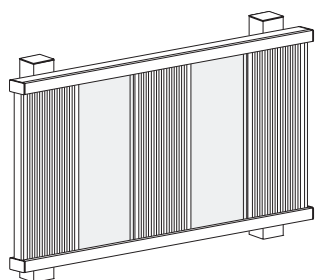

6 Patterned rabote  
Rebrasti profili

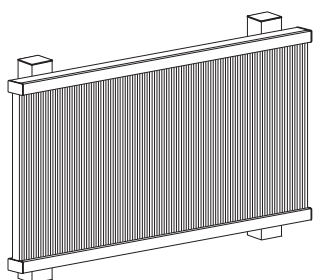

7 Patterned rabote in two levels  
Rebrasti profili u dva nivoa

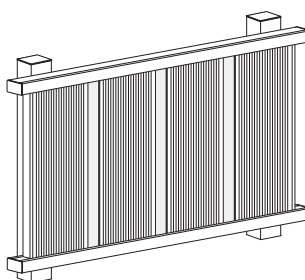

8 Patterned rabote in one level  
Rebrasti profili jednog nivoa

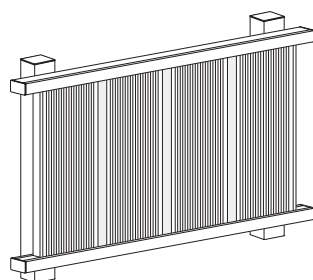

|   | Column / Stub     | Connection - Transom / Veza - Prečka | Vertical profiles / Vertikalni profili |
|---|-------------------|--------------------------------------|--|
| 1 | 998-104 / 994-910 | 823                                  | 029-008                                |
| 2 | 998-104 / 994-910 | 823                                  | 059-010                                |
| 3 | 998-104 / 994-910 | 823                                  | 070-002                                |
| 4 | F50-106           | F50-310 / F50-3K10 / F50-311         | 070-009 / 070-0K9                      |
| 5 | F50-106           | F50-310 / F50-3K10 / F50-311         | 070-009 / 994-907 / 070-0K9            |
| 6 | F50-106           | F50-310 / F50-3K10 / F50-311         | 070-011 / 070-0K9 / 070-K11            |
| 7 | F50-106           | F50-310 / F50-3K10 / F50-311         | 070-009 / 510-918 / 070-0K9            |
| 8 | F50-106           | F50-310 / F50-3K10 / F50-311         | 070-009 / 070-019 / 070-0K9            |

Distance between vertical profiles, for types 1, 2, 3: 4 to 11cm

Rastojanje između vertikalnih profila, za tipove 1, 2, 3: 4 do 11cm

# Fence

## Ograde

## Horizontal constructions

## Horizontalna konstrukcija

Create your own fence choosing among the 14 different aluminium designs combining materials such as straight and oval aluminium, triplex glass 6mm, perforated aluminium sheet.

Kreirajte sopstvenu ogradu birajući između 14 različitih aluminijumskih modela kombinujući materijale kao što su ravni i ovalni aluminijum, triplex staklo 6mm, perforirani aluminijumski lim.

1 Internal-external curved rabote  
Unutra i spolja zaobljeni profil

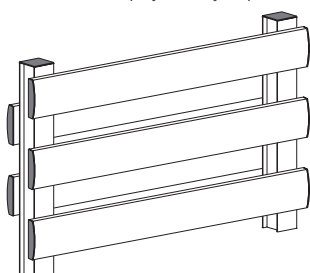

2 Internal curved rabote  
Unutrašnji zaobljeni profil

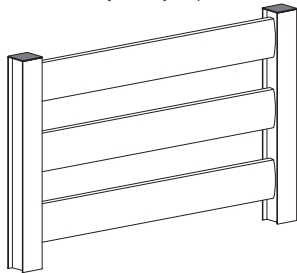

3 Internal curved rabote in angle  
Unutrašnji zaobljeni profil pod uglom

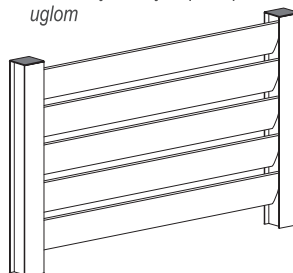

4 External curved rabote  
Spoljašnji zaobljeni profil

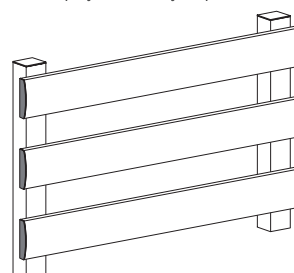

5 Patterned rabote with anod. profile  
Rebrasti profil sa elok. profilima

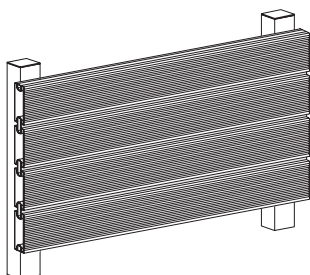

6 External rectangle profile 60mm  
Spoljašnji pravougaoni profil 60mm

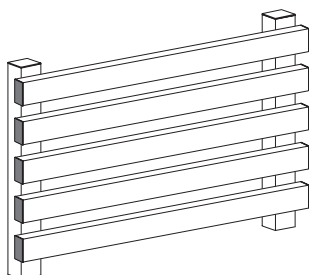

7 External square profile 20x20mm  
Spoljašnji kvadratni profil 20x20mm

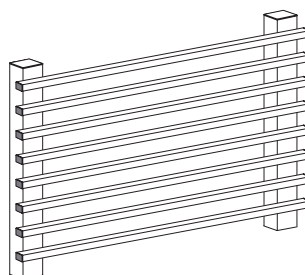

8 Patterned rabote with glass 6mm  
Rebrasti profil sa staklom od 6mm

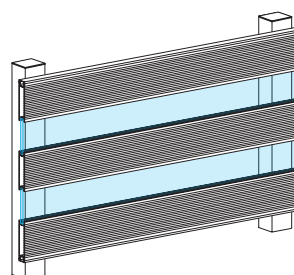

1  
2  
3  
4  
5  
6  
7  
8

|   | Column / Stub     | Horizontal profiles / Horizontalni profili |
|---|-------------------|--|
| 1 | 070-001           | 070-002                                    |
| 2 | 070-001           | 070-002                                    |
| 3 | 070-001           | 070-002                                    |
| 4 | 998-104 / 994-910 | 070-002                                    |
| 5 | 998-104 / 994-910 | 070-004 / 510-918 / 070-0K4                |
| 6 | 998-104 / 994-910 | 059-010                                    |
| 7 | 998-104 / 994-910 | 029-008                                    |
| 8 | 998-104 / 994-910 | 070-009 / 070-0K9                          |

Corner construction for types:  
Ugaona konstrukcija za tipove:

4 8 9 10 11 12

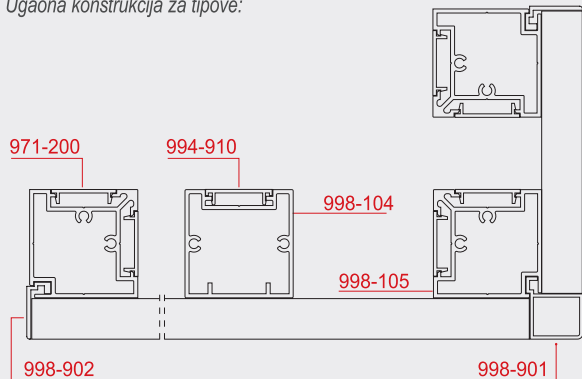

Corner construction for type:  
Ugaona konstrukcija za tipove:

13

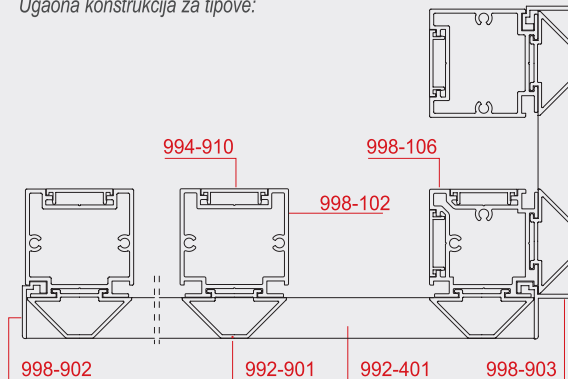

9 Patterned rabote with ianod. profile  
Rebrasti profili sa elok. profilima

10 Patterned rabote  
Rebrasti profili

11 Patterned rabote in two levels  
Rebrasti profili na dva nivoa

12 Patterned rabote in one level  
Rebrasti profili na jednom nivou

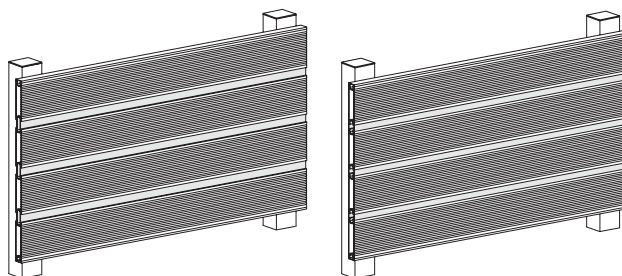
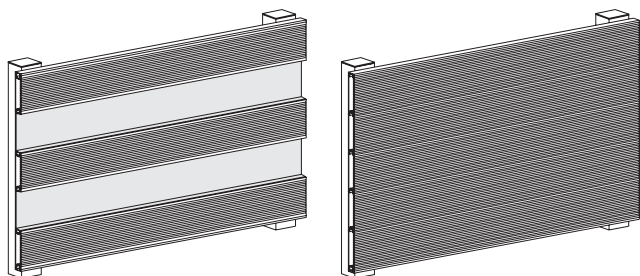

13 Fence with transom  
Ograda sa prečkom

14 Fence with blind horizontal sheet & perforated aluminium sheet  
Ograda sa horizontalnim neprovidnim i perforiranim Al limom

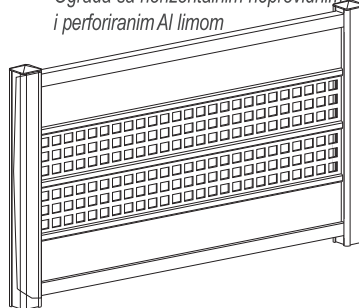
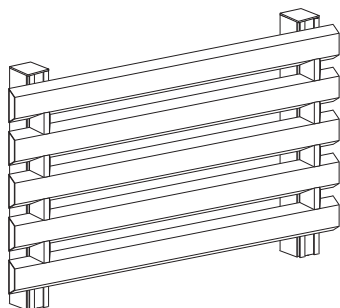

|    | Column / Stub               | Horizontal profiles / Horizontalni profil |
|----|-----------------------------|---|
| 9  | 998-104 / 994-910           | 070-009 / 994-907 / 070-0K9               |
| 10 | 998-104 / 994-910           | 070-011 / 070-K11 / 070-0K9               |
| 11 | 998-104 / 994-910           | 070-009 / 510-918 / 070-0K9               |
| 12 | 998-104 / 994-910           | 070-009 / 070-019 / 070-0K9               |
| 13 | 998-102 / 994-910 / 992-901 | 992-401                                   |
| 14 | 915 / 981                   | 979 / 980 / 095                           |



Columns & caps | Stubovi i poklopni profili | **Prodaja po m' , UNPAINTED = SIROVO; COLORED = RAL9016, RAL9005**

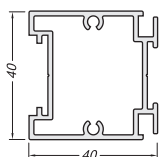

| 998-102   |         |
|-----------|---------|
| UNPAINTED | COLORED |
| 5,5 €/m   | 6,1 €/m |

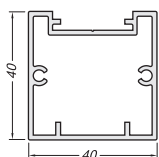

| 998-104   |         |
|-----------|---------|
| UNPAINTED | COLORED |
| 5,2 €/m   | 5,8 €/m |

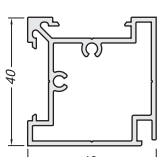

| 998-105   |         |
|-----------|---------|
| UNPAINTED | COLORED |
| 5,6 €/m   | 6,2 €/m |

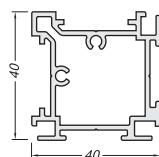

| 998-106   |         |
|-----------|---------|
| UNPAINTED | COLORED |
| 6,0 €/m   | 6,7 €/m |

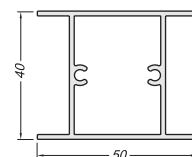

| 070-001   |         |
|-----------|---------|
| UNPAINTED | COLORED |
| 5,3 €/m   | 5,9 €/m |

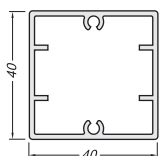

| F50-106   |         |
|-----------|---------|
| UNPAINTED | COLORED |
| 5,1 €/m   | 5,7 €/m |

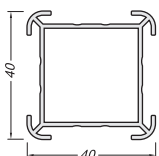

| 915       |         |
|-----------|---------|
| UNPAINTED | COLORED |
| 4,3 €/m   | 4,8 €/m |

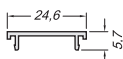

| 994-910   |         |
|-----------|---------|
| UNPAINTED | COLORED |
| 0,8 €/m   | 0,9 €/m |

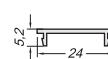

| 971-200   |         |
|-----------|---------|
| UNPAINTED | COLORED |
| 0,8 €/m   | 0,9 €/m |

End & corner profiles | Krajnji i ugaoni profili

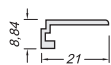

| 998-902   |         |
|-----------|---------|
| UNPAINTED | COLORED |
| 0,8 €/m   | 0,9 €/m |

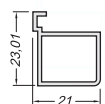

| 998-901   |         |
|-----------|---------|
| UNPAINTED | COLORED |
| 1,7 €/m   | 1,9 €/m |

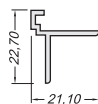

| 998-903   |         |
|-----------|---------|
| UNPAINTED | COLORED |
| 1,3 €/m   | 1,4 €/m |

Transoms | Prečke



| 823       |         |
|-----------|---------|
| UNPAINTED | COLORED |
| 4,5 €/m   | 5,0 €/m |

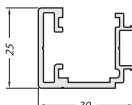

| F50-310   |         |
|-----------|---------|
| UNPAINTED | COLORED |
| 3,1 €/m   | 3,4 €/m |



| F50-3K10  |         |
|-----------|---------|
| UNPAINTED | COLORED |
| 1,1 €/m   | 1,2 €/m |

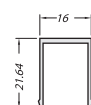

| F50-311   |         |
|-----------|---------|
| UNPAINTED | COLORED |
| 1,3 €/m   | 1,4 €/m |

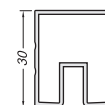

| 095       |         |
|-----------|---------|
| UNPAINTED | COLORED |
| 2,4 €/m   | 2,7 €/m |

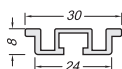

| 981       |         |
|-----------|---------|
| UNPAINTED | COLORED |
| 1,5 €/m   | 1,7 €/m |

# Fence Ograde

## System profiles | Profili sistema

Profiles, caps & inox elements | Profili, ispune | Prodaja po m', UNPAINTED = SIROVO; COLORED = RAL9016, RAL9005



070-002

| UNPAINTED | COLORED |
|-----------|---------|
| 5,4 €/m   | 6,0 €/m |



994-907

| UNPAINTED | COLORED |
|-----------|---------|
| 4,9 €/m   | 5,4 €/m |

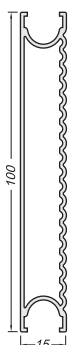

070-009

| UNPAINTED | COLORED |
|-----------|---------|
| 5,5 €/m   | 6,1 €/m |



070-011

| UNPAINTED | COLORED |
|-----------|---------|
| 5,6 €/m   | 6,2 €/m |

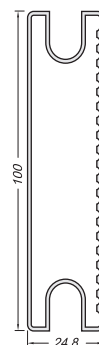

070-008

| UNPAINTED | COLORED |
|-----------|---------|
| 6,5 €/m   | 7,2 €/m |



029-008

| UNPAINTED | COLORED  |
|-----------|----------|
| 5,0 €/kg  | 5,5 €/kg |



059-010

| UNPAINTED | COLORED  |
|-----------|----------|
| 5,0 €/kg  | 5,5 €/kg |

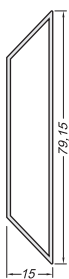

992-401

| UNPAINTED | COLORED |
|-----------|---------|
| 3,7 €/m   | 4,1 €/m |



992-901

| UNPAINTED | COLORED |
|-----------|---------|
| 2,2 €/m   | 2,4 €/m |



070-K11

| UNPAINTED | COLORED |
|-----------|---------|
| 1,0 €/m   | 1,1 €/m |

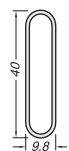

510-918

| UNPAINTED | COLORED  |
|-----------|----------|
| 5,0 €/kg  | 5,5 €/kg |

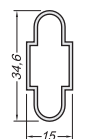

070-019

| GALVANIZED |
|------------|
| 2,2 €/m    |



070-0K4

| UNPAINTED | COLORED |
|-----------|---------|
| 0,9 €/m   | 1,0 €/m |



070-0K9

| UNPAINTED | COLORED |
|-----------|---------|
| 1,1 €/m   | 1,2 €/m |



980

| UNPAINTED | COLORED |
|-----------|---------|
| 1,4 €/m   | 1,6 €/m |

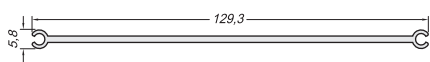

979-200

| UNPAINTED | COLORED |
|-----------|---------|
| 4,5 €/m   | 5,0 €/m |



# Gates

## Kapije

System profiles | Profili sistema

Profiles | Profili | Prodaja po m' , UNPAINTED = SIROVO; COLORED = RAL9016, RAL9005

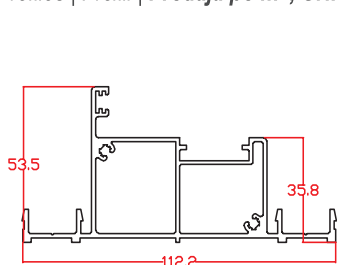

994-101

| UNPAINTED | COLORED  |
|-----------|----------|
| 10,2 €/m  | 11,3 €/m |

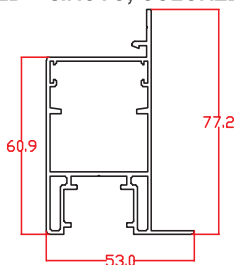

994-201

| UNPAINTED | COLORED |
|-----------|---------|
| 7,6 €/m   | 8,4 €/m |

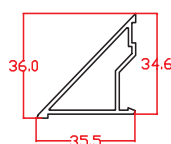

994-901

| UNPAINTED | COLORED |
|-----------|---------|
| 2,8 €/m   | 3,1 €/m |

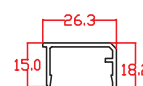

994-1K1

| UNPAINTED | COLORED |
|-----------|---------|
| 1,4 €/m   | 1,6 €/m |

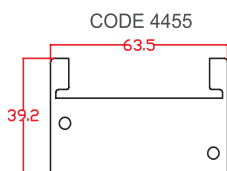

CODE 4455

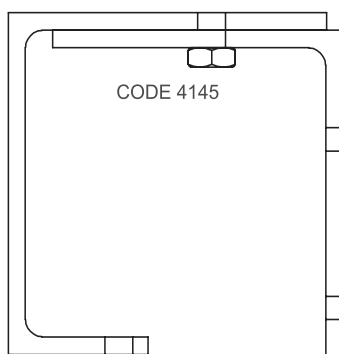

CODE 4145

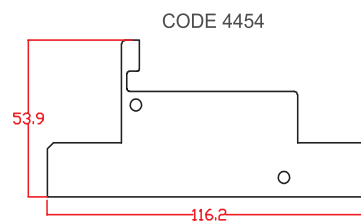

CODE 4454

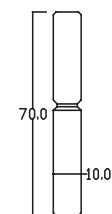
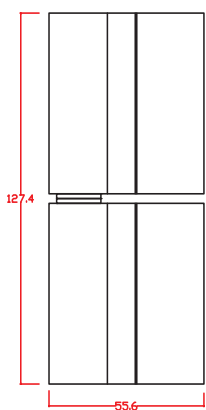
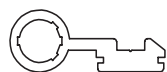

CODE 4197

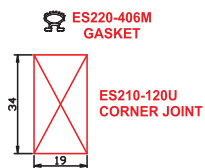

EA510-207U ALIGNMENT ANGLE

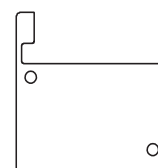

CODE 4456

## Horizontalni preseci

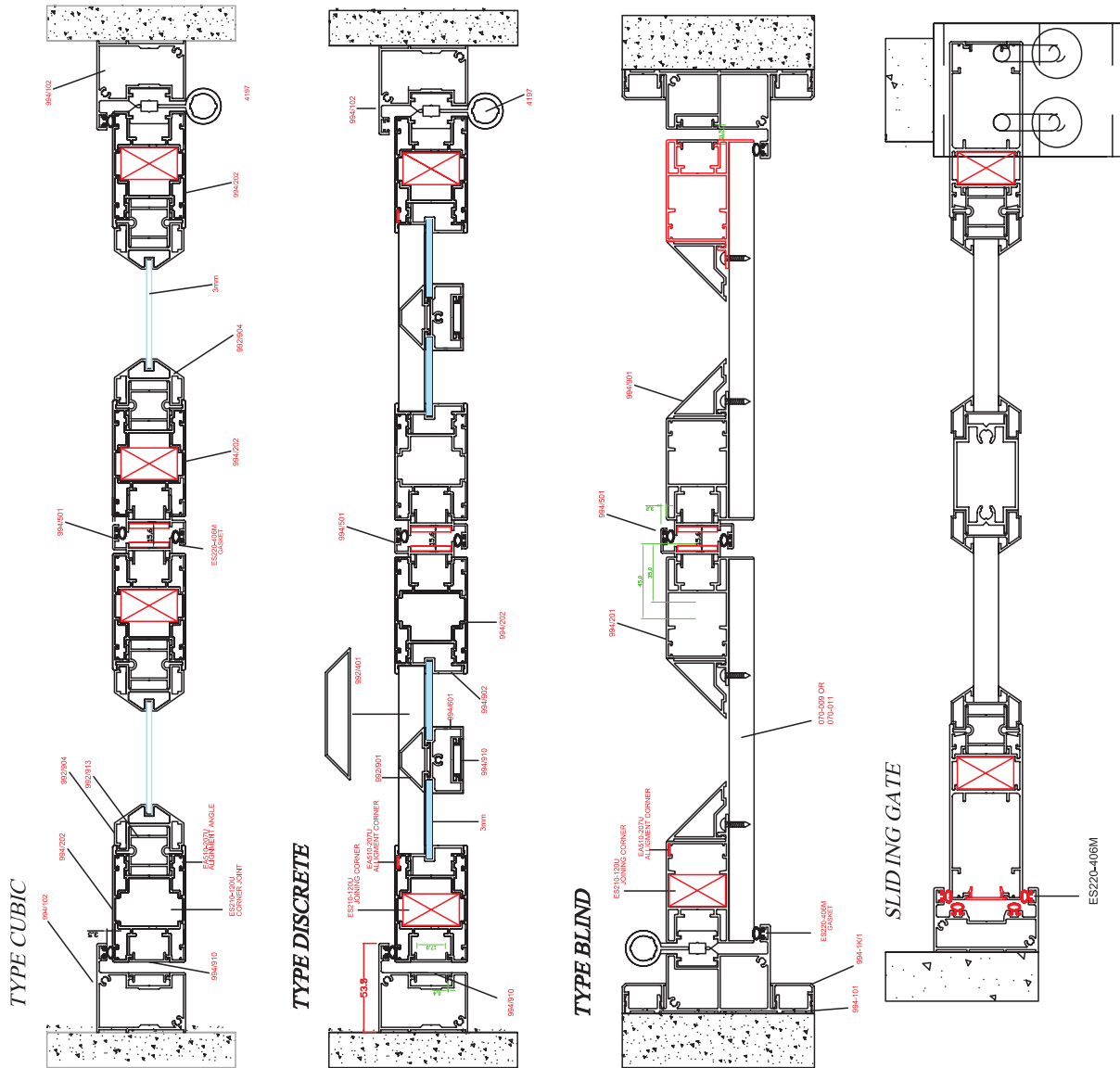

## Vertikalni preseci

TYPE CUBIC

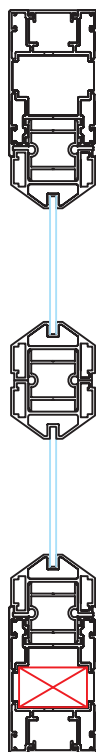

TYPE DISCRETE

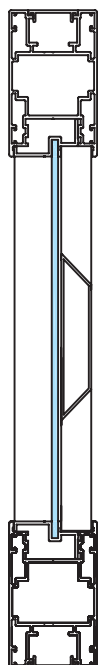

TYPE BLIND

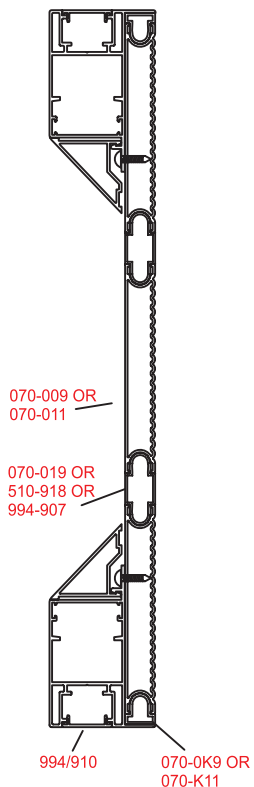

SLIDING GATE

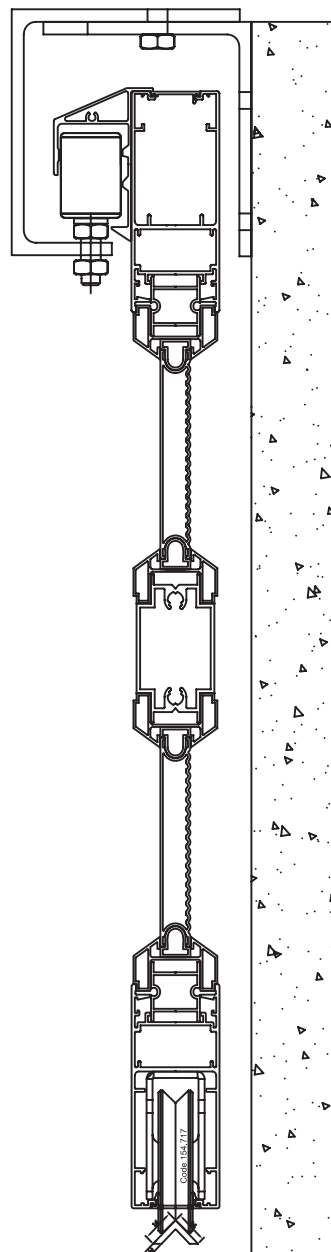



**ALUMINCO**<sup>®</sup>  
ALUMINIUM BUILDING SYSTEMS

aluminium Railing Systems |

Sistemi ograda  
Aluminium Geländersysteme



 All railing systems are certified by recognized institutes, such as IFT Rosenheim Germany, Istituto Giordano Italy, EKANAL (Accredited Testing Laboratory) Greece etc. The powder coating of ALUMINCO products is based on QUALICOAT and SEASIDE CLASS specifications (seaside class process). The company also applies a quality management system according to EN ISO 9001 and environmental management system according to EN ISO 14001.

 Svi sistemi ograda su sertifikovani od priznatih instituta, kao što su IFT Rosenheim Nemačka, Istituto Giordano Italija, EKANAL (Akreditovana Laboratorija Testiranja) Grčka itd. Plastifikacija ALUMINCO proizvoda je bazirana na QUALICOAT i SEASIDE CLASS specifikacijama (primorska klasa). Kompanija takođe primenjuje sistem kvaliteta menadžmenta u skladu sa EN ISO 9001 i sistema upravljanja životnom sredinom u skladu sa EN ISO 14001.

 Alle Geländersysteme werden von anerkannten Instituten zertifiziert, wie das IFT Rosenheim Deutschland, das Istituto Giordano Italiens, das Zentrum zur Qualitätskontrolle von Aluminium Griechenlands (EKANAL) u.a. Das Lackierungsverfahren der Produkte von ALUMINCO erfolgt auf der Grundlage der Richtlinien QUALICOAT und SEASIDE CLASS (Verarbeitung von meeresnahen Kategorien) und es wird ein Qualitätsmanagementsystem nach EN ISO 9001 und ein entsprechendes Umweltmanagementsystem nach EN ISO 14001 angewandt.



## F50 Inox type

Sistem ograde F50 tipa INOX  
Geländersystem F50 typ INOX



## Crystal Line

Sistem staklenih ograda Crystal Line  
Glasrahmenstützsystem Crystal Line

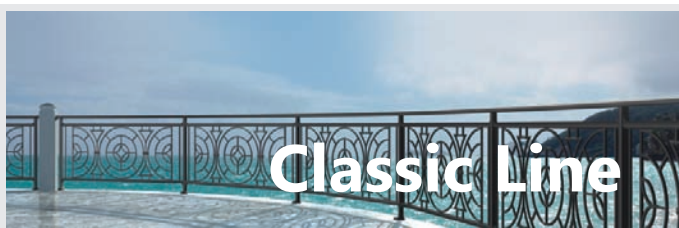

## Classic Line

Sistem klasičnih ograda  
Traditionelle aluminiumgeländer



## Fencing Systems

Dvorišni sistemi  
Umzäunungssysteme

aluminco

Aluglobe  
katalog sa  
cenovnikom  
2013





F50 Sistem ograda je eloksirani u skladu sa metodom sumporne kiseline i proizvodnja zadovoljava standarde za debljinu površinske zaštite MIL-A-8625 Type II. Procedura pruža:

- Prosečna debljina površinske zaštite 20µm
- Standardni sjaj kao četkani nerđajući čelik

#### Prednosti eloksaže:

Eloksaža je jedinstveni finiš koji ispunjava visoke standarde kvaliteta i ima značajne prednosti:

- Veliku Otpornost. Izuzetno dug vek trajanja i mali troškovi održavanja.
- Stabilnost boje. Eloksaža pruža visoku otpornost na UV zračenje i ne ljušti se i ne puca.
- Lako održavanje. F50 eloksirani delovi lako mogu da se očiste i da ostanu novi korišćenjem prirodne vode, blagog sapuna i mekane krpe.
- Visoke estetike. Za razliku od drugih površinskih zaštita, eloksaža dopušta aluminijumu da zadrži svoj metalni izgled, sličan tipu Inox.
- Bezbedna i izdržljiva. Eloksaža je stabilan hemijski proces. Nije toksična, ne truli i veoma je otporna na visoke temperature.

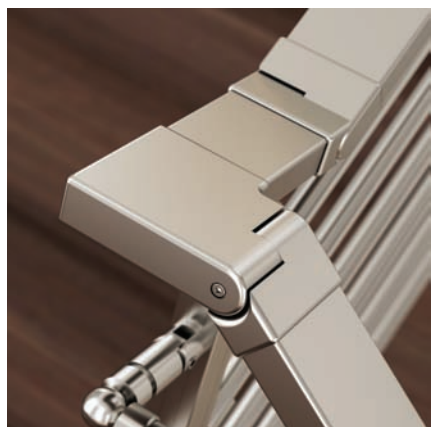

Das F50 Geländer-System wird nach der Schwefelsäure-Technik anodisiert und die Produktion entspricht der Anforderungen für moderate. Dicke-Beschichtungen MIL-A-8625 Typ II. Diese Technik bietet:

- Moderate Beschichtung 20µm
- Standard Farbtönung und Glanz wie Edelstahl

Vorteile des Anodisieren Das Anodisieren ist ein einzigartiger Oberfl äche-Endeffekt, das hohe Qualitätsstandards erfüllt und wesentliche Vorteile hat:

- Großer Widerstand. Extrem lange Lebensdauer und geringe Wartungskosten.
- Farbstabilität. Das Anodisieren bietet hohe Beständigkeit gegen UV-Strahlung, platzt nicht ab und knackt nicht auf.
- Einfache Wartung. F50 anodisierte Bestandteile bleiben brandneu und können leicht mit natürlichem Wasser, milder Seife und einem weichen Tuch gereinigt werden.
- Hohe Ästhetik. Im Gegensatz zu anderen Oberfl ächen, ermöglicht das Anodisieren des Aluminiums, es sein metallisches Aussehen zu behalten, ähnlich wie bei rostfreiem Stahl.
- Niedrige Kosten. Installations- und Wartungskosten deutlich geringer im Vergleich zu rostfreiem Stahl.
- Sicher und langlebig. Das Anodisieren ist ein chemisch stabiler Prozess. Es ist nicht giftig, zersetzt nicht und ist sehr widerstandsfähig gegen Hitze.

# Crystal Line glass support system

Crystal Line sistem staklenih ograda | Glasrahmenstützsystem Crystal Line

 ALUMINCO, a leader in the design and production of aluminium railings, presents a new patented glass support system with aluminum profile. Crystal Line system is ideal for applications on balconies and stairs with high architectural requirements. It offers an impressive aesthetic and operational result without restricting the view. No maintenance is required; it is easy to clean and is manufactured according to UNI EN 10807:1999, NF P01-013:1988 & NF P08-301:1991 standards.

**Crystalline**<sup>®</sup>  
railing system

Crystal Line system is available in 3 basic types (floor, in-floor and external) with many variations. It can be placed on the floor or on a parapet accommodating a glass of 16 or 20mm thickness (triplex, securit) with special finishing or even be combined with 4 different aluminum balustrades. Round Ø50, oval 76mm with channel for the glass and 2 with external support for a Ø50 balustrade.



ALUMINCO, prednjači u dizajnu i proizvodnji aluminijskih ograda, predstavlja novi patent sistema staklene ograde sa aluminijskim profilima. Cristal Line sistem je idealan za balkone i stepeništa sa visokim arhitektonskim zahtevima.

Pružna impresivnu estetiku i operacioni rezultat bez ograničavanja pogleda. Nije potrebno održavanje; jednostavno za čišćenje i proizveden je u skladu sa standardima UNI EN 10807:1999, NF P01-013:1988 & NF P08-301:1991.

Cristal Line sistem je dostupan u 3 osnovna tipa (podni, ugradni u pod i vanjski) sa raznim varijacijama. Može biti postavljen na završenom podu ili na parapetu sa staklom od 16

ili 20mm debljine (triplex, securit) sa specijalnim doradama ili da se čak kombinuje sa 4 različite aluminijske ograde. Okrugli Ø50, ovalni 76mm sa kanalom za staklo i 2 sa vanjskim držačima za Ø50 ograde.

Aluglobe  
katalog sa  
cenovnikom  
2013

33

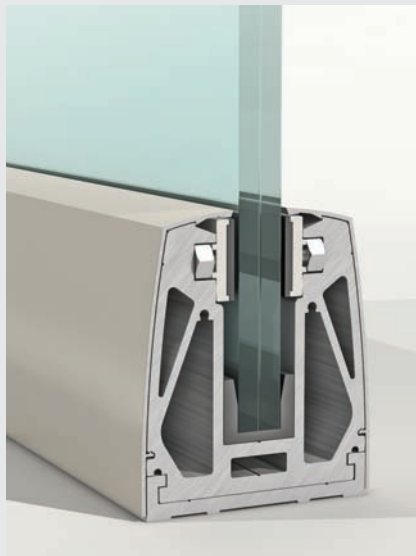
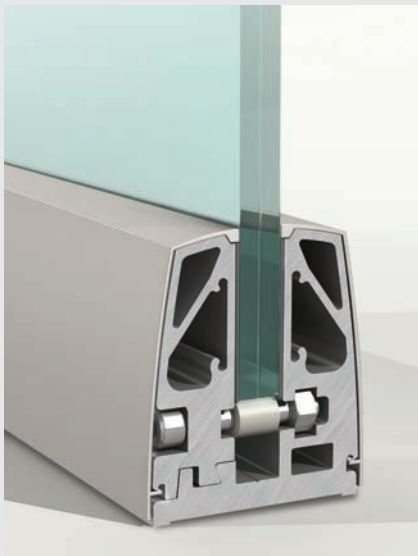

## Type A



- Perfect aesthetic result.
- Unlimited view.
- Easy cleaning.
- Maintenance free.



- Savršen estetski rezultat.
- Neograničen pogled.
- Lako se čisti.
- Bez održavanja.



- Perfekte Ästhetik.
- Unbegrenzte Sicht.
- Einfache Reinigung.
- Wartungsfrei.

## Type B

- Vertical and horizontal adjustment.
- Special guide for bases support.
- Glazing support by lateral pressure plates.
- Glazing 16 or 20mm (triplex, securit).
- Ideal for swimming pools.
- Perfect alignment.

- Vertikalno i horizontalno regulisanje.
- Posebna vođica za osnovu držača.
- Držač zastakljivanja sa pločama bočnog pritiska.
- Staklo od 16 ili 20mm(triplex, securit).
- Idealno za bazene.
- Savršeno ravno.

- Vertikale und horizontale Verstellung.
- Spezielle Führung für Grundträger.
- Verglasung Unterstützung durch seitlichen Druck Platten.
- Verglasung 16 oder 20mm (triplex, securit).
- Ideal für Schwimmbäder.

## Type C

- A system with maximum stability.
- Supporting the glazing with tightening plates and gaskets.
- Glass of 16 or 20mm thickness.

- Sistem sa max. stabilnošću.
- Držač stakla sa zateznim pločama i zaptivkama.
- Staklo od 16 ili 20mm (triplex, securit).

- System mit maximaler Stabilität.
- Unterstützung der Verglasung mit speziellen Klammer-Teile.
- Glass von 16 oder 20mm Dicke.



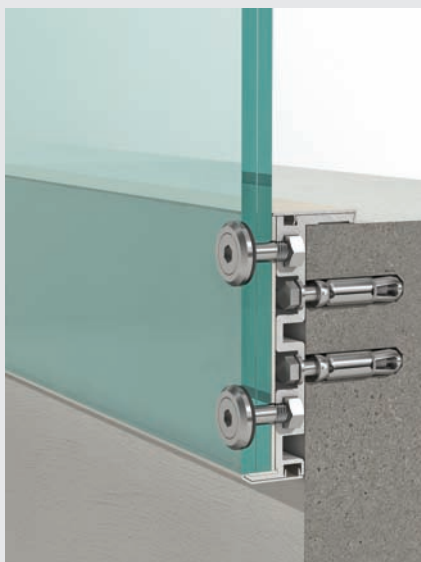
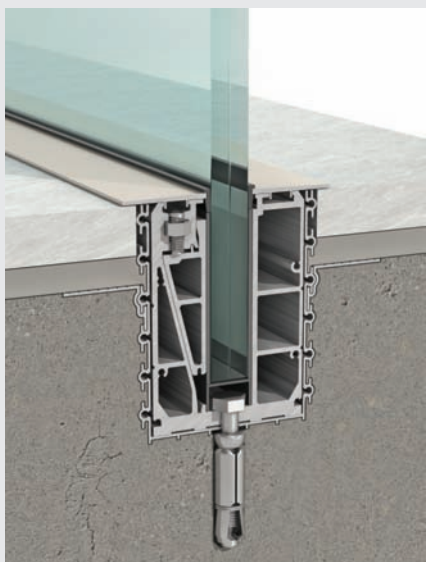

## Type Cu

- In floor glass supporting system leveled on the floor
- Glass of 16 or 20mm thickness.
- Easy to assemble
- Staklo od 16 ili 20mm (triplex, securit).
- Staklo ugrađeno u podu sa pričvrsnim sistemom u ravni sa podom
- Jednostavna montaža.
- In-floor Glass System auf dem Boden eingeebnet.
- Glass von 16 oder 20mm Dicke.
- Einfach zu montieren.

## Type D

- Ideal for facade applications.
- Unlimited view.
- Glass of 16 or 20mm thickness (triplex, securit).
- Idealan za fasadne aplikacije.
- Neograničen pogled.
- Staklo od 16 ili 20mm (triplex, securit).
- Ideal für Fassaden-Anwendungen.
- Unbegrenzte Sicht.
- Glass von 16 oder 20mm Dicke (Triplex securit).

## Type Ds

- Easy mounting.
- Optimal for stair application.
- Glass of 16 up to 20mm thickness (triplex, securit).
- Minimal design.
- Jednostavna montaža.
- Idealan za primenu na stepenistu.
- Staklo od 16 ili 20mm (triplex, securit).
- Minimalan dizajn.
- Einfacher Aufbau
- Optimale Anwendung für Treppen.
- Glass von 16 oder 20mm Dicke (Triplex securit).
- Minimal Design.



aluminco

## | Railtop / Rukohvat

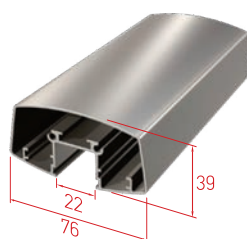
Oval  
Ovalni

|                            |           |
|----------------------------|-----------|
| Code                       | F85-200   |
| Length / Dužina            | 6 m       |
| Price RAL / Cena RAL       | 9,00 €/m  |
| Anodized Inox / Eloks Inox | 10,90 €/m |

Round  
Okrugli

|                            |           |
|----------------------------|-----------|
| Code                       | F85-201   |
| Length / Dužina            | 6 m       |
| Price RAL / Cena RAL       | 9,10 €/m  |
| Anodized Inox / Eloks Inox | 11,00 €/m |

Round  
Okrugli

|                            |          |
|----------------------------|----------|
| Code                       | F50-200  |
| Length / Dužina            | 6 m      |
| Price RAL / Cena RAL       | 5,60 €/m |
| Anodized Inox / Eloks Inox | 5,90 €/m |

## | Gaskets / Gume

F85-200/201 gasket for glass 16mm  
Guma F85-200/201 za staklo 16mm

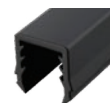

|                 |          |
|-----------------|----------|
| Code            | F85-405M |
| Length / Dužina | 50 m     |
| Price / Cena    | 1,00 €/m |

F85-200/201 gasket for glass 20mm  
Guma F85-200/201 za staklo 20mm



|                 |            |
|-----------------|------------|
| Code            | EA 410-420 |
| Length / Dužina | 350 m      |
| Price / Cena    | 0,13 €/m   |

## | Railtop accessories / Pribor za rukohvat

Railtop cap  
Bočni poklopac za  
rukohvat

|                            |             |
|----------------------------|-------------|
| Code                       | F85-403     |
| Package / Pakovanje        | 80 kom.     |
| Price / Cena RAL           | 2,40 €/kom. |
| Anodized Inox / Eloks Inox | 2,90 €/kom. |

Railtop cap  
Bočni poklopac za  
rukohvat

|                            |             |
|----------------------------|-------------|
| Code                       | F85-404     |
| Package / Pakovanje        | 80 kom.     |
| Price / Cena RAL           | 1,40 €/kom. |
| Anodized Inox / Eloks Inox | 1,70 €/kom. |

Railtop cap  
Bočni poklopac za  
rukohvat

|                            |             |
|----------------------------|-------------|
| Code                       | 4434        |
| Package / Pakovanje        | 50 kom.     |
| Price / Cena RAL           | 1,10 €/kom. |
| Anodized Inox / Eloks Inox | 2,00 €/kom. |

F85-201 Railtop connector  
Muf za rukohvat F85-201

|                            |             |
|----------------------------|-------------|
| Code                       | 4251        |
| Package / Pakovanje        | 40 kom.     |
| Price / Cena RAL           | 1,50 €/kom. |
| Anodized Inox / Eloks Inox | 1,80 €/kom. |

Railtop wall support  
Rozetna za zid

|                            |             |
|----------------------------|-------------|
| Code                       | F85-402     |
| Package / Pakovanje        | 45 kom.     |
| Price / Cena RAL           | 3,90 €/kom. |
| Anodized Inox / Eloks Inox | 4,40 €/kom. |

Railtop wall support  
F50-200  
Rozetna za zid sa  
poklopcem F50-200

|                            |             |
|----------------------------|-------------|
| Code                       | 4509Z       |
| Package / Pakovanje        | 20 kom.     |
| Price / Cena RAL           | 3,80 €/kom. |
| Anodized Inox / Eloks Inox | 5,00 €/kom. |

Railtop support F50-200  
Držac rukohvata F50-200

|                            |             |
|----------------------------|-------------|
| Code                       | F85-451     |
| Package / Pakovanje        | 25 kom.     |
| Price / Cena RAL           | 8,50 €/kom. |
| Anodized Inox / Eloks Inox | 9,70 €/kom. |

Railtop support F50-200  
Držac rukohvata F50-200

|                     |              |
|---------------------|--------------|
| Code                | 4148         |
| Package / Pakovanje | 12 kom.      |
| Inox                | 13,60 €/kom. |

Type A On-floor glass supporting system  
Podni noseči sistem

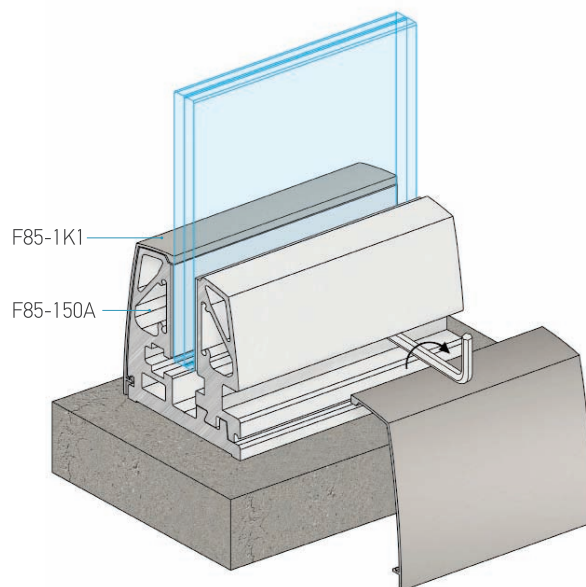
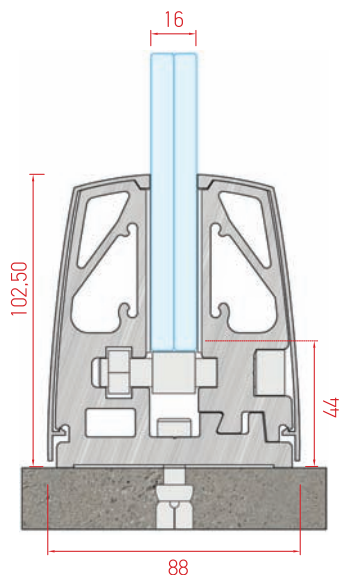

Type A: Alignment / Poravnanje

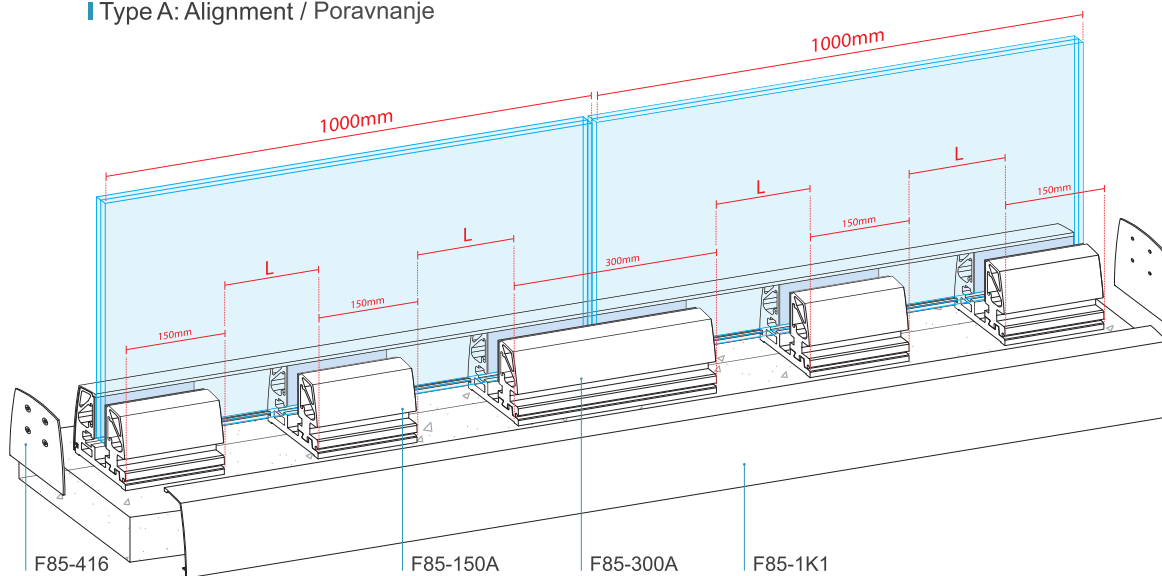

## Profiles & Accessories / Profili i oprema

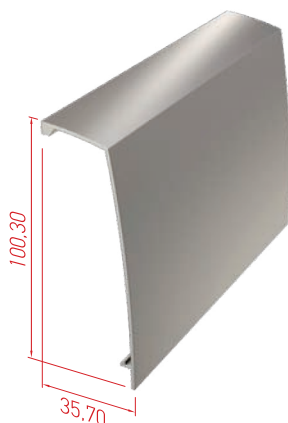

Base cover  
Pokrivni Profil

|                             |                |
|-----------------------------|----------------|
| Code                        | <b>F85-1K1</b> |
| Weight / Težina             | 550 gr/m       |
| Length / Dužina             | 6 m            |
| Price / Cena RAL            | 4,50 €/m       |
| Anodized Inox<br>Eloks Inox | 5,70 €/m       |



Cap  
Poklopac

|                             |                |
|-----------------------------|----------------|
| Code                        | <b>F85-416</b> |
| Package<br>Pakovanje        | 20 kom.        |
| Price / Cena RAL            | 4,40 €/kom.    |
| Anodized Inox<br>Eloks Inox | 5,00 €/kom.    |



Cap  
Poklopac

|                             |                 |
|-----------------------------|-----------------|
| Code                        | <b>F85-416L</b> |
| Package<br>Pakovanje        | 20 kom.         |
| Price / Cena RAL            | 4,80 €/kom.     |
| Anodized Inox<br>Eloks Inox | 5,50 €/kom.     |

## Glass supporting base / Nosači stakla

*Bases include screws and pressure gaskets.  
Uz nosače idu šrafovi i gume.*



|                      |                 |
|----------------------|-----------------|
| Code                 | <b>F85-150A</b> |
| Package<br>Pakovanje | 12 kom.         |
| Price / Cena         | 15,50 €/kom.    |



|                      |                 |
|----------------------|-----------------|
| Code                 | <b>F85-300A</b> |
| Package<br>Pakovanje | 6 kom.          |
| Price / Cena         | 28,00 €/kom.    |

## Price per meter / Cena po metru

*Indicative price/m with 3 supporting bases and covers in anodized Inox.  
Cena je indikativna/m sa 3 osnovna nosača i poklopca u Inox eloksaži.*

Price /  
Cena: **57,90 €/m**

*Glass and fixed screws are not included.  
Staklo i šrafovi nisu u ceni.*

## Extra color charge Specijalni RAL

*Prices concern coating RAL9016 and RAL9005.*

*U cenu su uračunati RAL9016 i RAL9005.*

|                                  |      |
|----------------------------------|------|
| RAL                              | +10% |
| Special Colors<br>Specijalni RAL | +15% |

# Type B

Adjustable on floor glass supporting system  
Podesivi podni sistemi

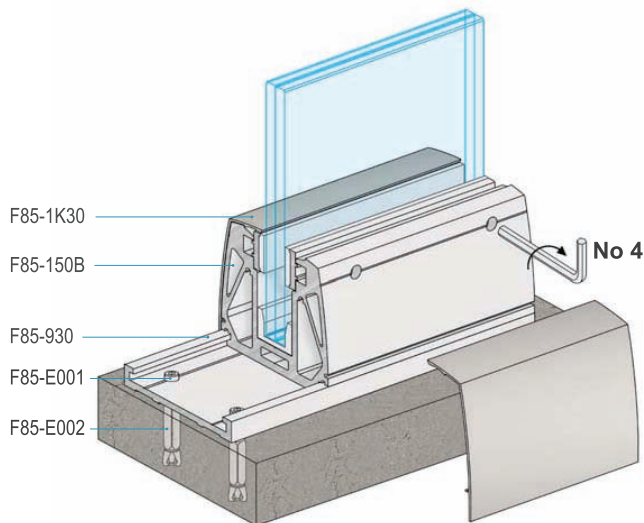
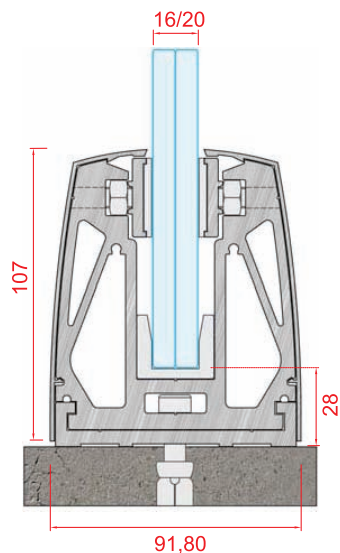

## Type B: Alignment / Poravnanje

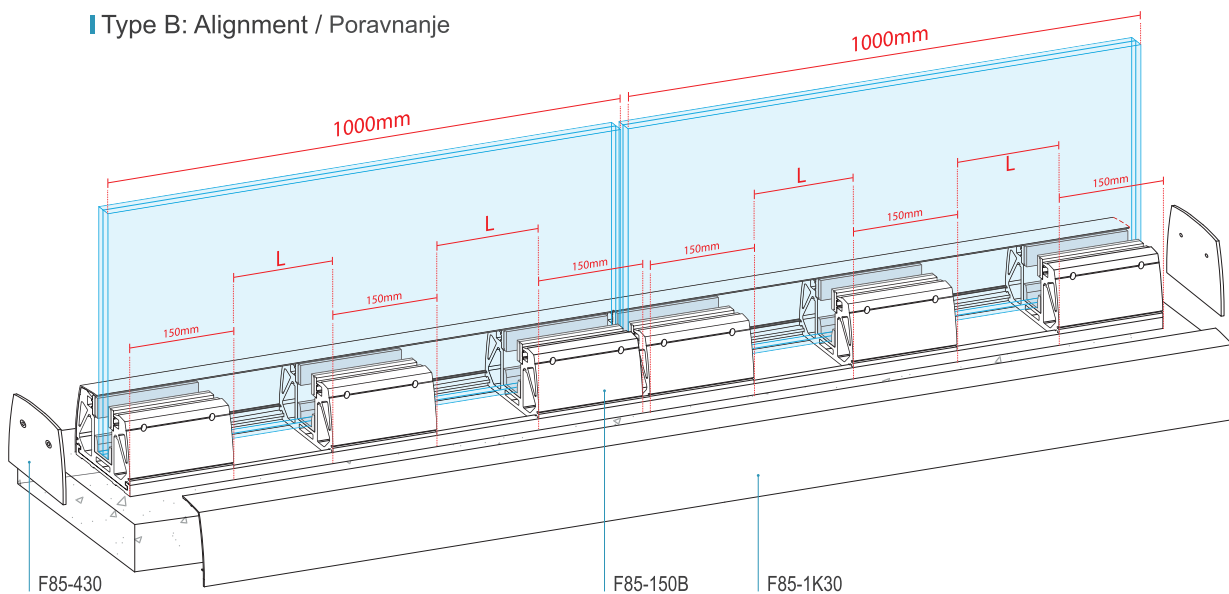



## Profiles & Accessories / Profili i oprema

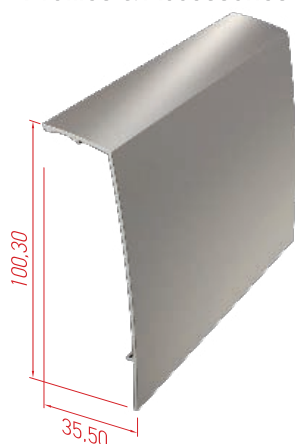

Base cover  
Pokrivni Profil

|                             |          |
|-----------------------------|----------|
| Code                        | F85-1K30 |
| Weight / Težina             | 545 gr/m |
| Length / Dužina             | 6 m      |
| Price / Cena RAL            | 4,50 €/m |
| Anodized Inox<br>Eloks Inox | 5,70 €/m |

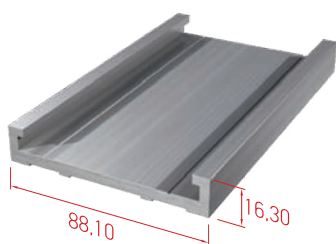

Base guide  
Sina nosača

|                  |           |
|------------------|-----------|
| Code             | F85-930   |
| Weight / Težina  | 1565 gr/m |
| Length / Dužina  | 6 m       |
| Price / Cena RAL | 12,10 €/m |

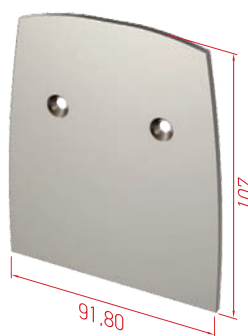

Cap  
Poklopac

|                             |             |
|-----------------------------|-------------|
| Code                        | F85-430     |
| Package<br>Pakovanje        | 20 kom.     |
| Price / Cena RAL            | 4,40 €/kom. |
| Anodized Inox<br>Eloks Inox | 5,00 €/kom. |

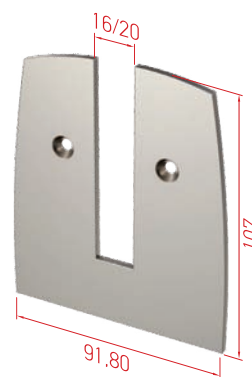

Cap  
Poklopac

|                             |                                    |
|-----------------------------|------------------------------------|
| Code                        | F85-430L (16mm)<br>F85-430M (20mm) |
| Package<br>Pakovanje        | 20 kom.                            |
| Price / Cena RAL            | 4,80 €/kom.                        |
| Anodized Inox<br>Eloks Inox | 5,50 €/kom.                        |

## Glass supporting base / Nosачi stakla

Bases include screws, gaskets and pressure plates.  
Uz nosače idu šrafovi, gume i ploče.



For glass 16mm\*  
Za staklo 16mm\*

|                      |              |
|----------------------|--------------|
| Code                 | F85-150B/16  |
| Package<br>Pakovanje | 12 pcs.      |
| Price / Cena         | 18,20 €/pcs. |



For glass 20mm  
Za staklo 20mm

|                      |              |
|----------------------|--------------|
| Code                 | F85-150B/20  |
| Package<br>Pakovanje | 12 pcs.      |
| Price / Cena         | 18,20 €/pcs. |

\* in case of using a 16mm glass,  
cover gasket is compulsory.  
u slučaju korišćenja stakla od  
16mm, guma je obavezna.



|                  |          |
|------------------|----------|
| Code             | F85-434  |
| Length<br>Dužina | 250 m    |
| Price /<br>Cena  | 0,30 €/m |

## Price per meter / Cena po metru

Indicative price/m with 3 supporting  
bases, covers in anodized Inox and 1m  
guide.  
Cena je indikativna/m sa 3 osnovna  
nosača, poklopcima u Inox eloksaži i sa  
1m šine.

Price / Cena 78,10 €/m

Glass and fixed screws are not included.  
Staklo i šrafovi nisu u ceni.

## Extra color charge Specijalni RAL

Prices concern coating RAL9016 and  
RAL9005.  
U cenu su uračunati RAL9016 i  
RAL9005.

|                                  |      |
|----------------------------------|------|
| RAL                              | +10% |
| Special Colors<br>Specijalni RAL | +15% |

**Type C** On-floor glass supporting system  
Podni noseći sistemi

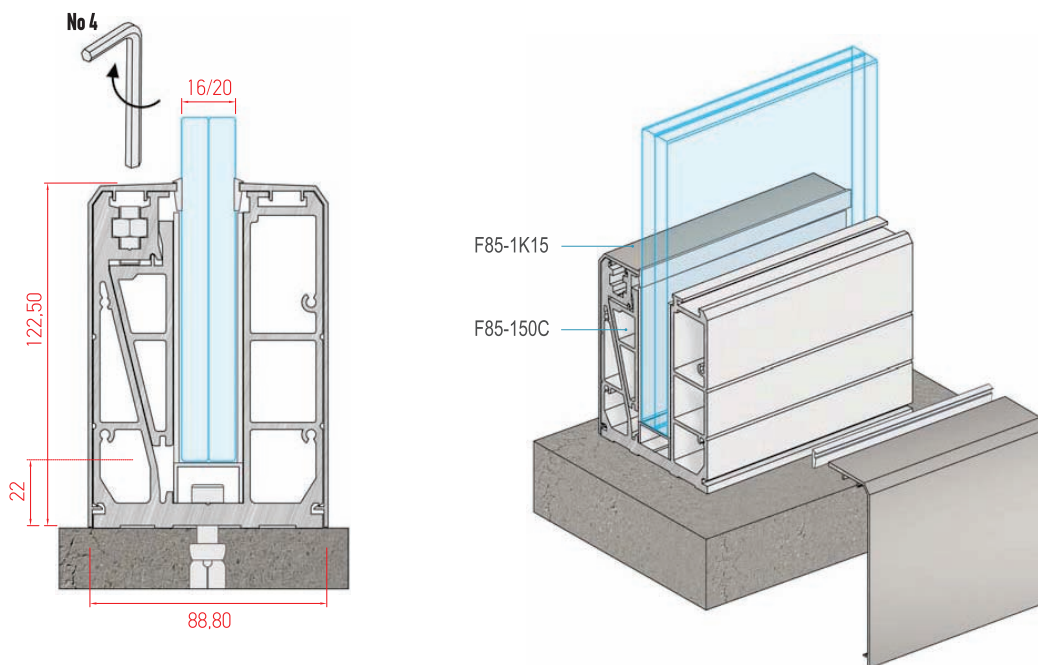

**Type C: Alignment / Poravnanje**

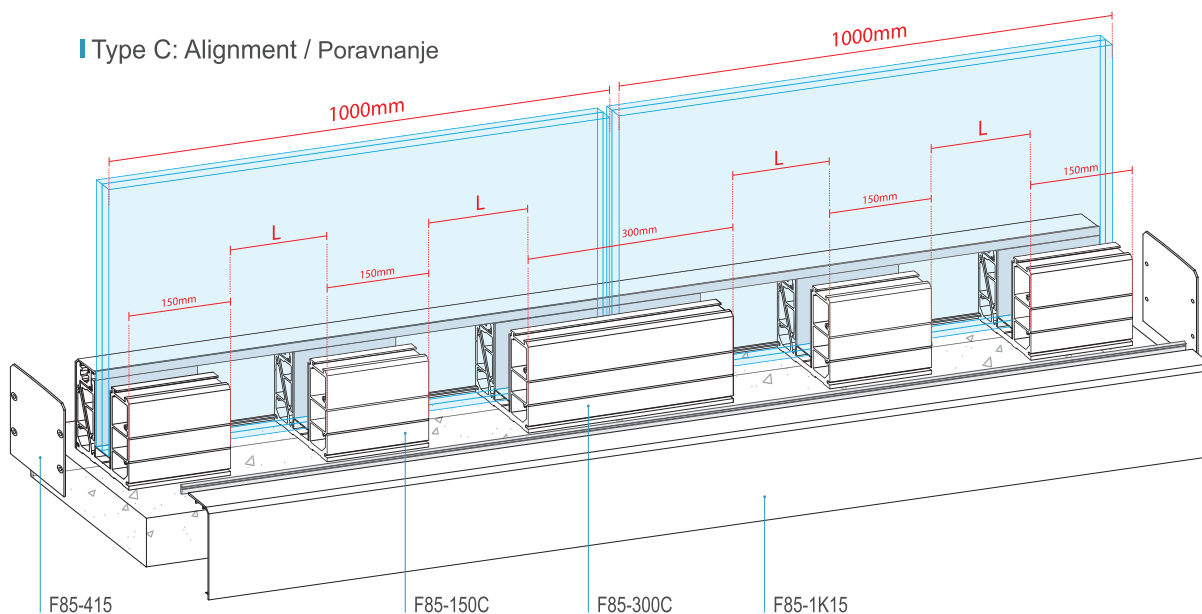

## Profiles & Accessories / Profili i oprema



Base cover  
Pokrivni Profil

|                             |                 |
|-----------------------------|-----------------|
| Code                        | <b>F85-1K15</b> |
| Weight / Težina             | 696 gr/m        |
| Length / Dužina             | 6 m             |
| Price / Cena RAL            | 5,70 €/m        |
| Anodized Inox<br>Eloks Inox | 7,00 €/m        |



Cap  
Poklopac

|                      |                 |
|----------------------|-----------------|
| Code                 | <b>F85-415</b>  |
| Package<br>Pakovanje | 20 kom.         |
| Price/Cena           | <b>4,80/kom</b> |



Cap  
Poklopac

|                             |  |
|-----------------------------|--|
| Code                        | <b>F85-415L</b> (16mm)<br><b>F85-415M</b> (20mm) |
| Package<br>Pakovanje        | 20 kom.  |
| Price / Cena RAL            | 5,30 €/kom.                                      |
| Anodized Inox<br>Eloks Inox | 6,10 €/kom.                                      |

## Glass supporting base / Nosači stakla

Bases include screws and gaskets. Type C bases are used in both in-floor and on-floor systems.

Uz nosače idu šrafovi i gume. Nosaci Tipa C se koriste u oba sistema, u podu i na podu.



Code  
**F85-150C/16\***  
**F85-150C/20\*\***

|                      |              |
|----------------------|--------------|
| Package<br>Pakovanje | 12 kom.      |
| Price / Cena         | 18,80 €/kom. |



Code  
**F85-300C/16\***  
**F85-300C/20\*\***

|                      |              |
|----------------------|--------------|
| Package<br>Pakovanje | 6 kom.       |
| Price / Cena         | 31,40 €/kom. |

\* For glass 16mm / Za staklo 16mm

\*\* For glass 20mm / Za staklo 20mm

## Price per meter / Cena po metru

Indicative price/m with 3 supporting bases and covers in anodized Inox. Cena je indikativna / m sa 3 nosača i poklopcima u Inox eloksaži.

Price / Cena **70,40 €/m**

Glass and fixed screws are not included. Staklo i šrafovi nisu u ceni.

## Extra color charge Specijalne boje

Prices concern coating RAL9016 and RAL9005.

U cenu su uračunati RAL9016 i RAL9005.

|                                  |      |
|----------------------------------|------|
| RAL                              | +10% |
| Special Colors<br>Specijalni RAL | +15% |

# Type Cu

In-floor glass supporting system  
Noseći sistem ugradni u pod

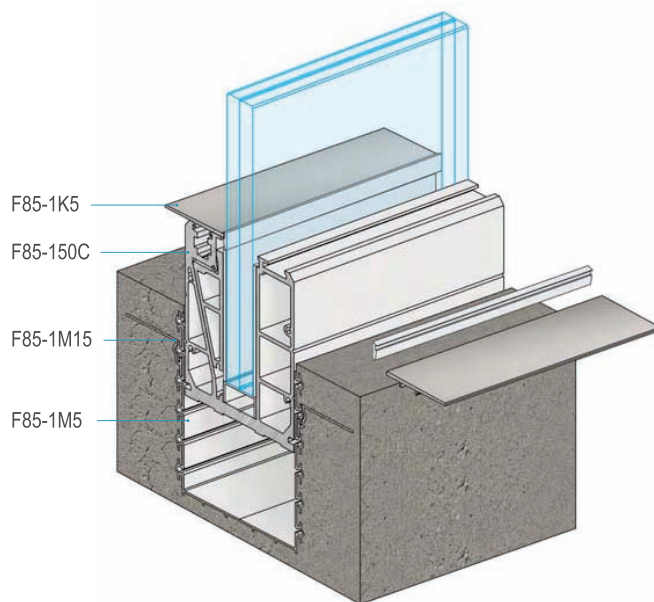
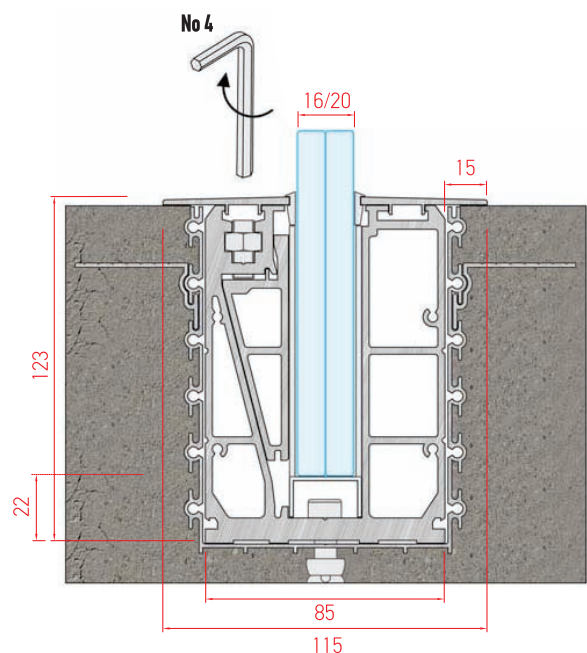

Type Cu: Alignment / Poravnanje

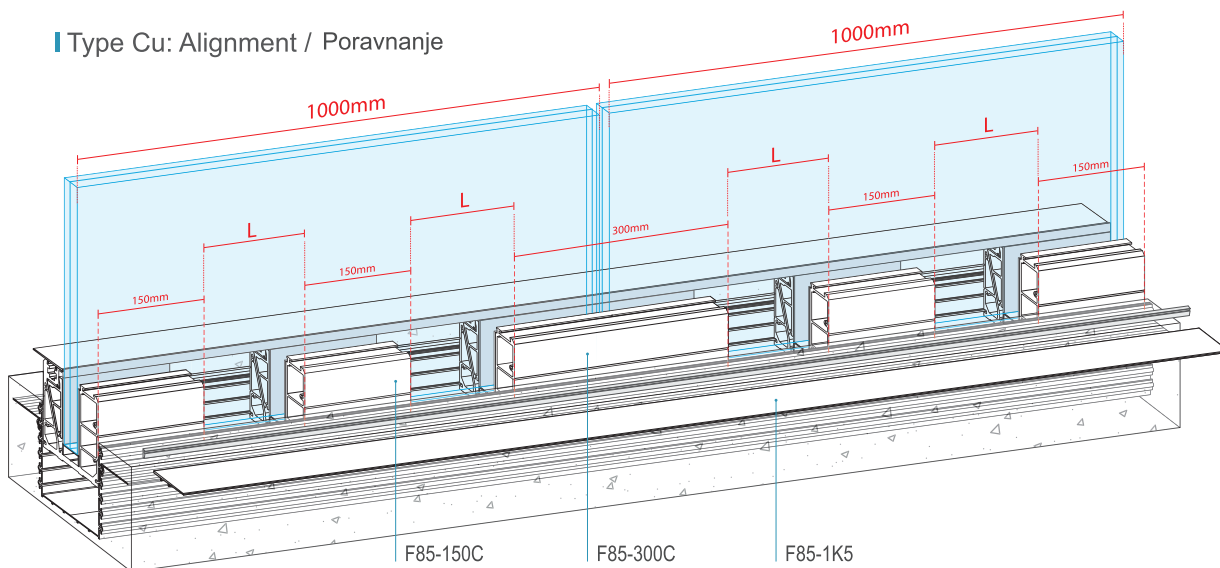

## Profiles &amp; Accessories / Profili i oprema

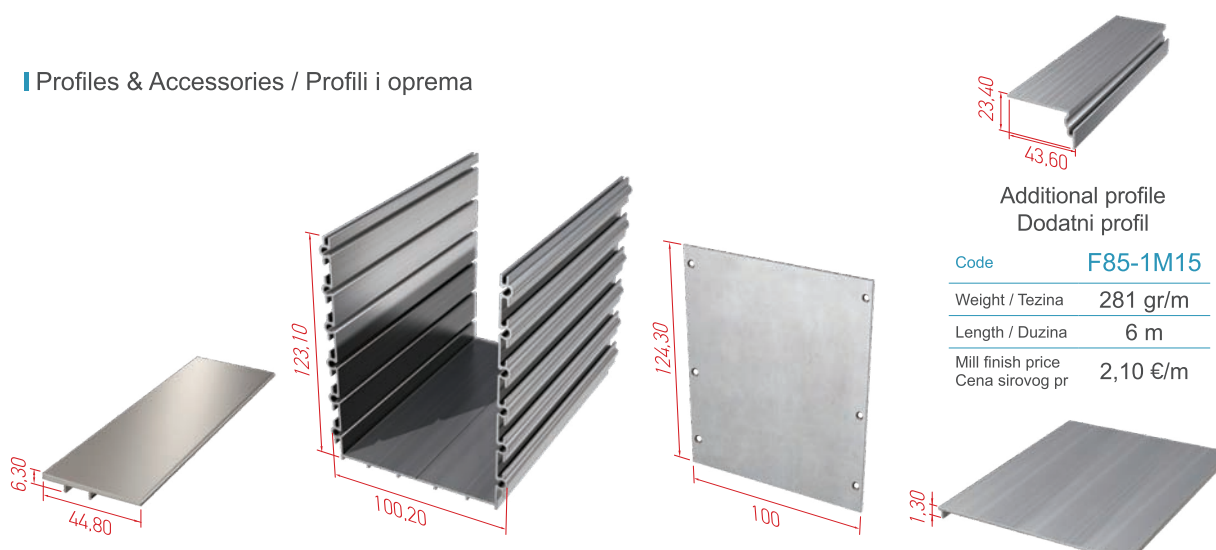

| Base cover<br>Pokrivni Profil |          | In-floor guide<br>Vodjica u podu     |           | End cap for in-floor guide<br>Bočni poklopac za vodjicu u podu |             | Cover for in-floor guide<br>Poklopac za šinu u podu |          |
|-------------------------------|----------|--------------------------------------|-----------|--|-------------|---|----------|
| Code                          | F85-1K5  | Code                                 | F85-1M5   | Code   | F85-425     | Code  | F85-1M25 |
| Weight / Težina               | 295 gr/m | Weight / Težina                      | 1976 gr/m | Package<br>Pakovanje   | 20 kom.     | Weight / Težina                                     | 360 gr/m |
| Length / Dužina               | 6 m      | Length / Dužina                      | 6 m       | Mill finish price<br>Cena sirovog pr.                          | 3,20 €/kom. | Length / Dužina                                     | 6 m      |
| Price / Cena RAL              | 2,40 €/m | Mill finish price<br>Cena sirovog pr | 15,30 €/m | Mill finish price<br>Cena sirovog pr.                          | 3,20 €/kom. | Mill finish price<br>Cena za sirov pr.              | 2,60 €/m |
| Anodized Inox<br>Eloks Inox   | 3,00 €/m |                                      |           |  |             |   |          |

## Mantling an in-floor guide / Montaža u podu

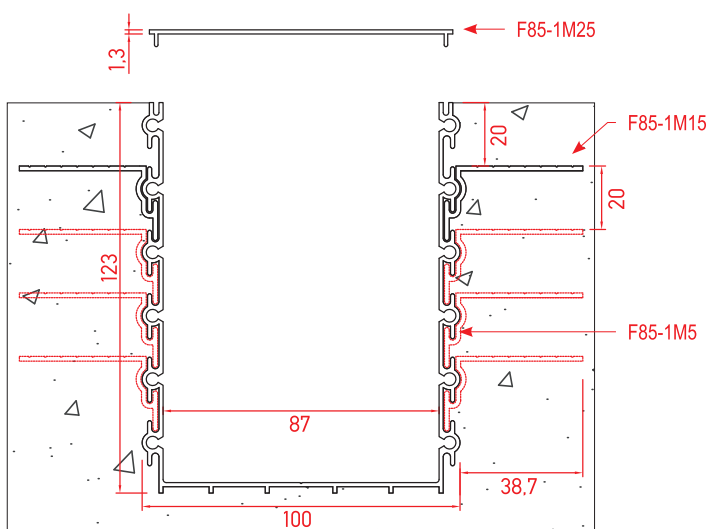

## Price per meter / Cena po metru

Indicative price/m with 3 supporting bases and covers in anodized Inox.  
Cena je indikativna/m sa 3 nosača i poklopca u Inox eloksazi

Price /  
Cena: 62,40 €/m

Glass and fixed screws are not included.  
Staklo i šrafovi nisu u ceni.

Indicative price/m for in-floor guide with end cap and additional profile.  
Indikativna cena/m za šinu u podu sa bočnim poklopcem i dodatnim profilom.

Price /  
Cena: 22,10 €/m

Extra color charge  
Specijalne boje

Prices concern coating RAL9016 and RAL9005.  
U cenu je uračunat RAL9016 i RAL9005.

|                                  |      |
|----------------------------------|------|
| RAL                              | +10% |
| Special Colors<br>Specijalni RAL | +15% |

# TypeD

External glass supporting system  
Sistem za spoljni nosač stakla

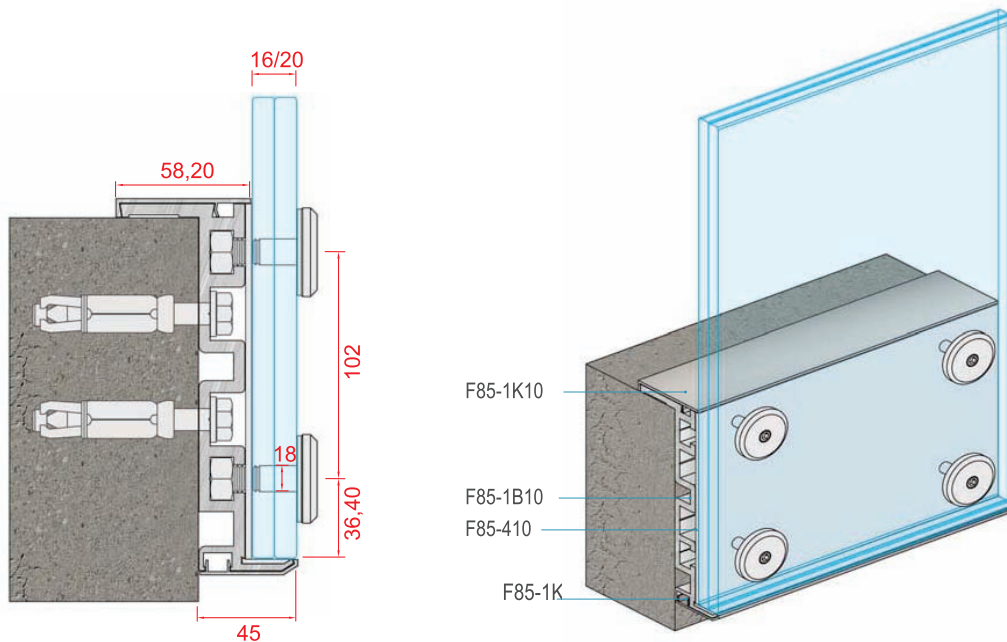

I Type D: Alignment / Poravnanje

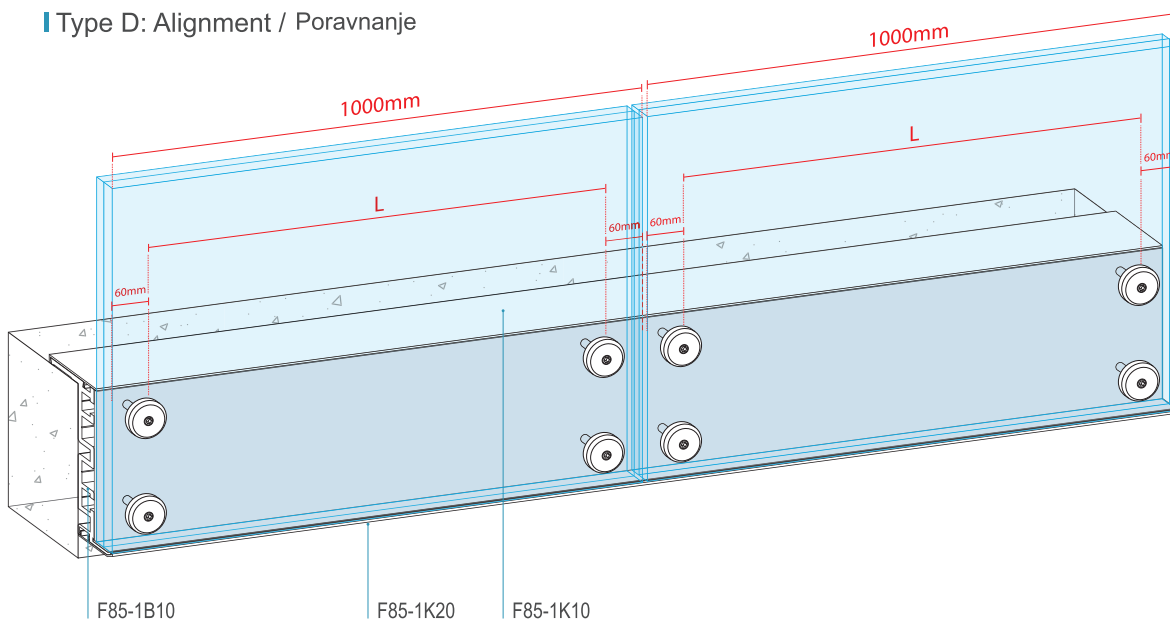

## Profiles & Accessories / Profili i oprema

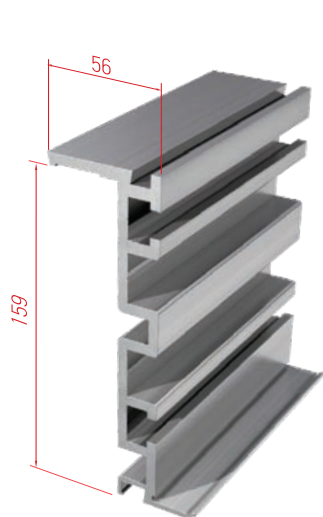

External base  
Spoljni nosač

|                                      |           |
|--------------------------------------|-----------|
| Code                                 | F85-1B10  |
| Weight / Težina                      | 4740 gr/m |
| Length / Dužina                      | 6 m       |
| Mill finish price<br>Cena sirovog pr | 36,50 €/m |

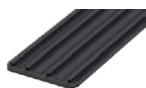

Base gasket  
Podnožna guma

|                 |          |
|-----------------|----------|
| Code            | F85-437  |
| Length / Dužina | 200 m    |
| Price / Cena    | 0,40 €/m |

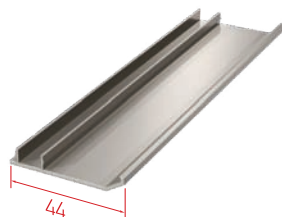

Bottom cover  
Donji poklopac

|                             |          |
|-----------------------------|----------|
| Code                        | F85-1K20 |
| Weight / Težina             | 220 gr/m |
| Length / Dužina             | 6 m      |
| Price / Cena RAL            | 1,80 €/m |
| Anodized Inox<br>Eloks Inox | 2,20 €/m |

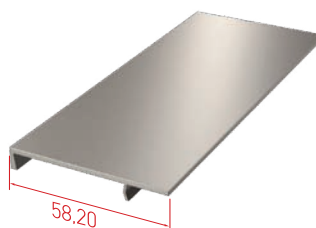

Upper cover  
Gornji poklopac

|                             |          |
|-----------------------------|----------|
| Code                        | F85-1K10 |
| Weight / Težina             | 366 gr/m |
| Length / Dužina             | 6 m      |
| Price / Cena RAL            | 3,10 €/m |
| Anodized Inox<br>Eloks Inox | 3,90 €/m |



PVC sheet 1mm  
PVC pločica 1mm

|                 |                          |
|-----------------|--------------------------|
| Code            | F85-410                  |
| Color<br>Boja   | White/Black<br>Bela/Crna |
| Length / Dužina | 2 m                      |
| Price / Cena    | 3,30 €/kom.              |

## Fixing glass rosette Rozeta za fiksiranje stakla



Fixing glass rosette 16mm  
Rozeta za fiksiranje stakla 16mm

|                     |             |
|---------------------|-------------|
| Code                | F85-D016    |
| Package / Pakovanje | 20 kom.     |
| Inox                | 6,60 €/kom. |

Fixing glass rosette 20mm  
Rozeta za fiksiranje stakla 20mm

|                     |             |
|---------------------|-------------|
| Code                | F85-D020    |
| Package / Pakovanje | 20 kom.     |
| Inox                | 6,80 €/kom. |

## Price per meter / Cena po metru

Indicative price/m with external base, upper and bottom covers in anodized Inox, 1m PVC sheet, base gasket and 4 fixing glass rosettes for 16mm glass.

Indikativna cena/m sa spoljnim nosačem, donjim i gornjim poklopcem u Inox eloksaži, 1m PVC lima, gumom za nosač i 4 rozete za fiksiranje stakla od 16mm.

|                  |           |
|------------------|-----------|
| Price /<br>Cena: | 71,05 €/m |
|------------------|-----------|

Glass and fixed screws are not included.  
Staklo i šrafovi nisu uključeni.

## Extra color charge / Specijalne boje

Prices concern coating RAL9016 and RAL9005.  
U cenu su uključeni RAL9016 i RAL9005.

|                                  |      |
|----------------------------------|------|
| RAL                              | +10% |
| Special Colors<br>Specijalni RAL | +15% |

Type **Ds**

INOX External glass supporting system  
INOX Sistem za spoljni nosač stakla

The connection of glasses is achieved through the rail top (with support 4148 or F85-451), thus improving the safety coefficient of the construction.

Veza između stakala se postiže pomoću gornje ploče (sa nosačem 4148 ili F85-451), što povećava koeficijent sigurnosti konstrukcije.

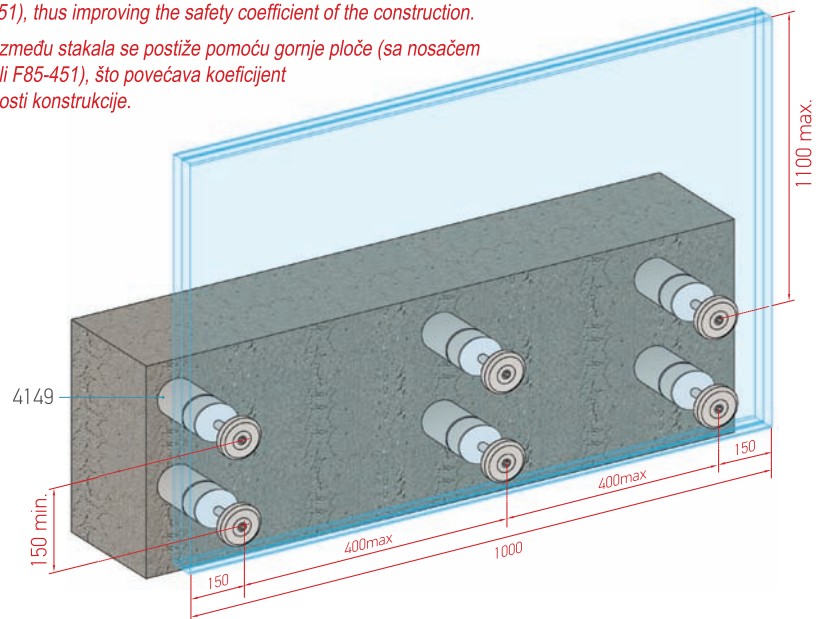
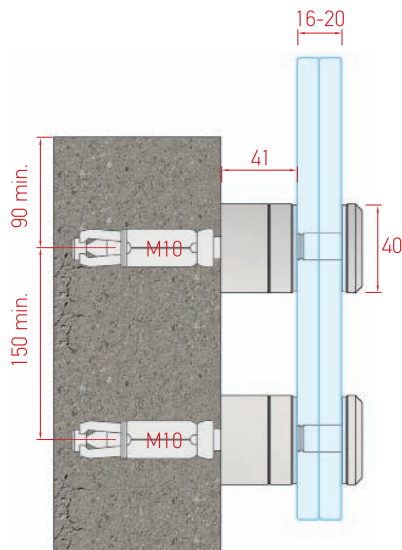

INOX External glass supporting system  
INOX Sistem za spoljni nosač stakla

\*Glass hole / Otvor za staklo

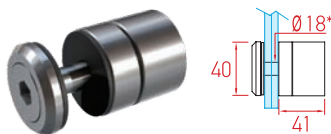

Fixing glass rosette 16-20mm  
Rozeta za stakla 16-20mm

|                     |              |
|---------------------|--------------|
| Code                | 4149         |
| Package / Pakovanje | 12 kom.      |
| Inox                | 19,60 €/kom. |

\*Glass hole / Otvor za staklo



Railtop support 16-20mm  
Nosač rukohvata 16-20mm

|                     |              |
|---------------------|--------------|
| Code                | 4148         |
| Package / Pakovanje | 12 kom.      |
| Inox                | 13,60 €/kom. |

Price per meter / Cena po metru

Indicative price/m with 6 fixing glass rosettes.  
Cena je indikativna po metru sa 6 rozeta za fiksiranje stakla.

Price / Prix: 117,60 €/m

Glass and fixed screws are not included.  
Staklo i šrafovi nisu uključeni.

Type A, B, C, Cu, D, Ds: Fixing screws / Šrafovi



Allen screw M10x70 Inox  
Imbus šraf M10x70 Inox

|                     |             |
|---------------------|-------------|
| Code                | F85-E001    |
| Package / Pakovanje | 50 kom.     |
| Price / Cena        | 0,70 €/kom. |



Metallic moly plug  
Metalni tipl

|                     |             |
|---------------------|-------------|
| Code                | F85-E002    |
| Package / Pakovanje | 50 kom.     |
| Price / Cena        | 0,95 €/kom. |

Technical data allen screw DIN 912  
Tehničke karakt. za imbus DIN 912

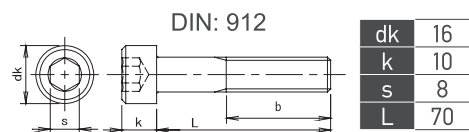

|    |    |
|----|----|
| dk | 16 |
| k  | 10 |
| s  | 8  |
| L  | 70 |



Shading Systems  
Sistemi zaštite od sunca

Pergolas / Pergole

[www.alumico.com](http://www.alumico.com)



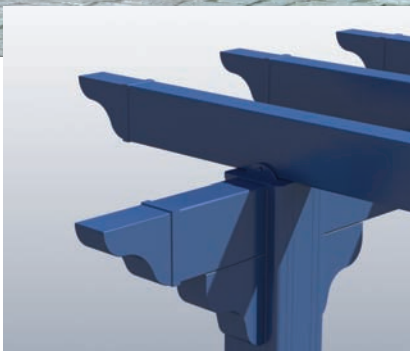

Designed in an identical line with that of classic wood pergolas.

Dizajnirana u identičnoj liniji kao klasična drvena pergola.

## Moderna

### With canvas roong

Another version of pergola, featuring a soft line of canvas on the fixed aluminium structure. The combination of modern pergolas with canvas offer additional shading to balconies, gardens etc.

### Sa platnom

Još jedna verzija pergole, karakteriše jednostavnu liniju platna na fiksnoj aluminijumskoj strukturi. Kombinacija moderne pergole sa platnom nudi dodatnu zaštitu od sunca na balkonima, vrtovima itd.

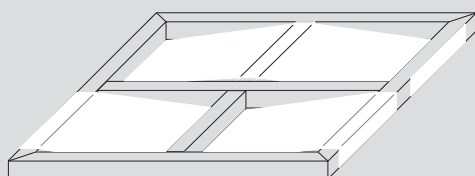

Modern - With canvas roong  
Moderna - Sa tendom



The use of woven canvas offers shading and a modern or traditional result, depending on the desirable style.

Upotreba pletene tende nudi sencenje u modernom ili tradicionalnom rešenju, u zavisnosti od zeljenog stila.



## Moderna

### With movable louver blades

The technological evolution in shading systems! An exceptional modern solution that was designed having two things in mind, functionality and high aesthetics. The pergola can be motorized, providing the best degree of sun-shading. It can be easily operated by means of a remote control.

### Sa pokretnim žaluzinama

Tehnološka evolucija u sistemima pergole. Izuzetno moderno rešenje koji je dizajniran imajući dve stvari na umu, funkcionalnost i visoku estetiku. Pergola može imati motorni pogon, pružajući najviši stepen zaštite od sunca. Jednostavno upotreba sa daljinskim upravljačem.

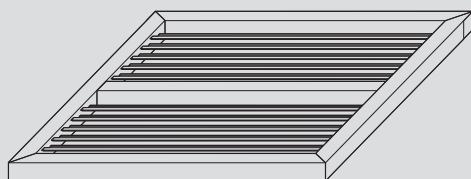

Modern - With movable louver blades  
Moderna - Sa pokretnim žaluzinama



Optional use of electrical mechanism.

Opcionalno korišćenje elektro mehanizma.



Plastic axle (Polyamide 6) offers stability, resistance and noiseless movement.

Plastična osovin (Poliamid 6) nudi stabilnost, otpornost i bezzvučno kretanje.

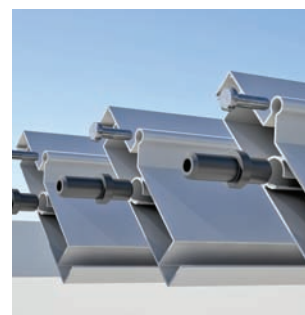



Pioneer gutter design that collects rainwater leading it to the column profile. It has been designed to be installed only to one direction or even around the construction.

Prvi u dizajnu oluka koji sakuplja kišnicu i vodi je u kolone profila. Dizajnirana je da bude instalirana samo u jednom smeru ili čak oko cele konstrukcije.

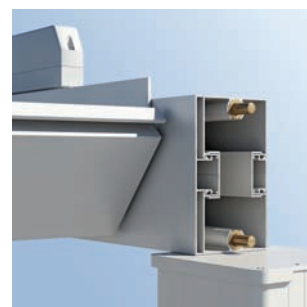
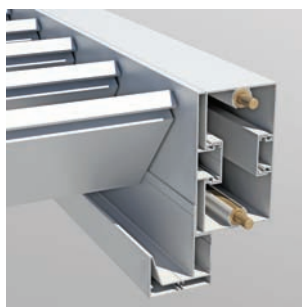

# Aplikacije

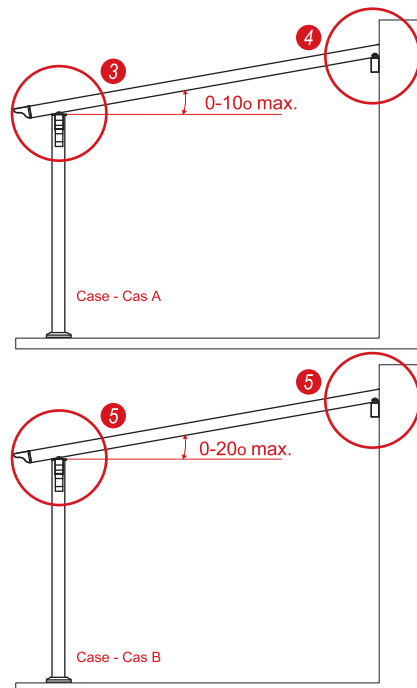
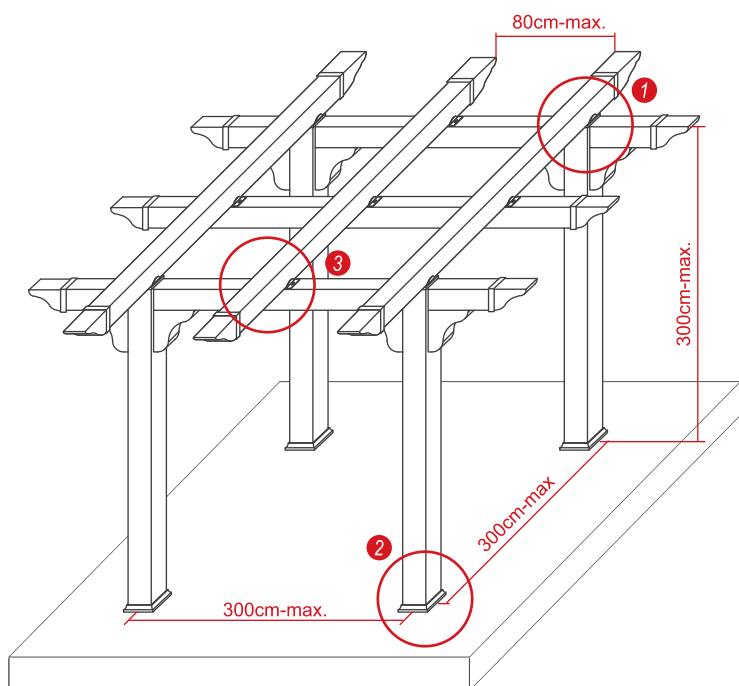

## Column process - Proces za stub

- 1 Inclination 0°.  
Nagib 0°.

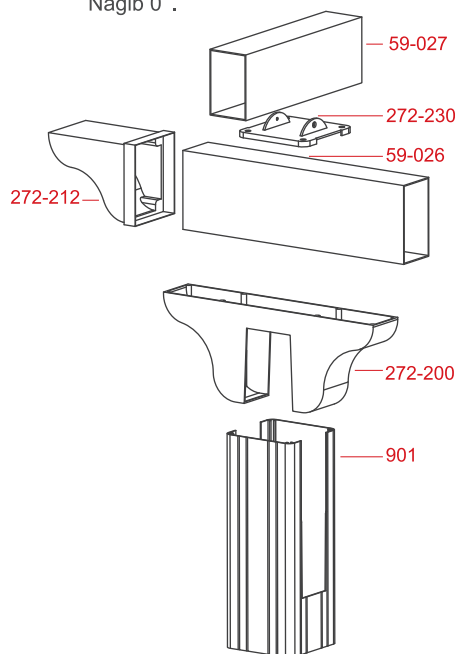

Column cutting o for the supporting base and the crossbar.

Stub za podršku baze i prečke.

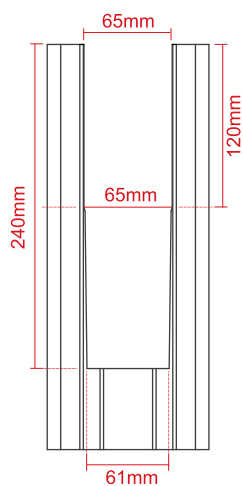

- 2 Column Support on ground.  
Noseći stub na podu

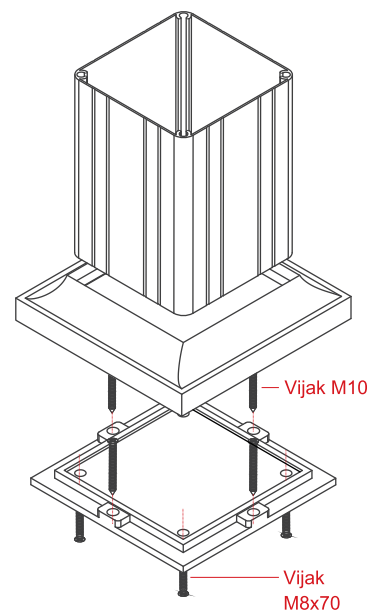

## Purlin Support - Rožnjača

- 3 Inclination up to 10°.  
Nagib do 10°.

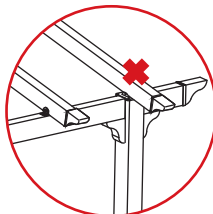
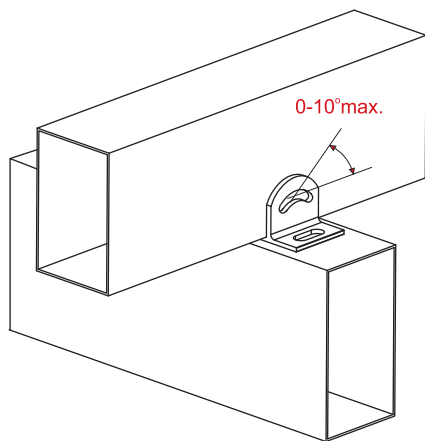

Wrong way of support.

Pogrešan način učvršćivanja

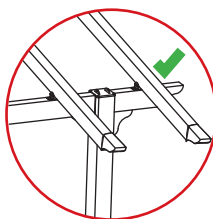

Correct way of support.

Ispravan način učvršćivanja.

- 4 Transom on wall.  
Spoj na zidu.

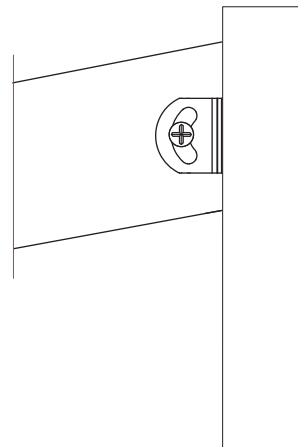

- 5 Inclination up to 20°.  
Nagib do 20°.

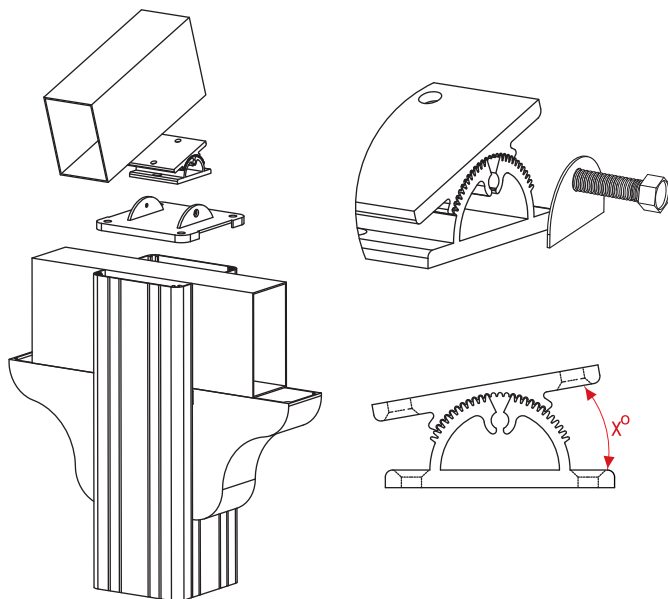

- 6 Transom on wall.  
Spoj na zidu.

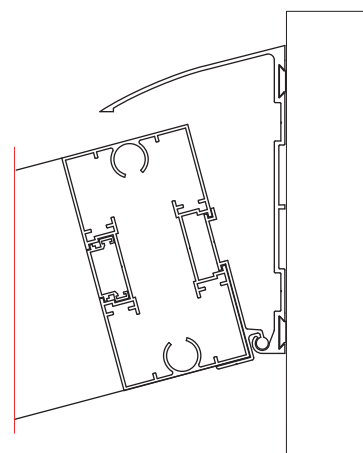

# Aplikacije

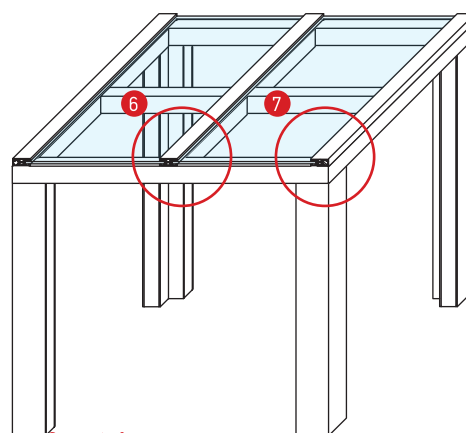
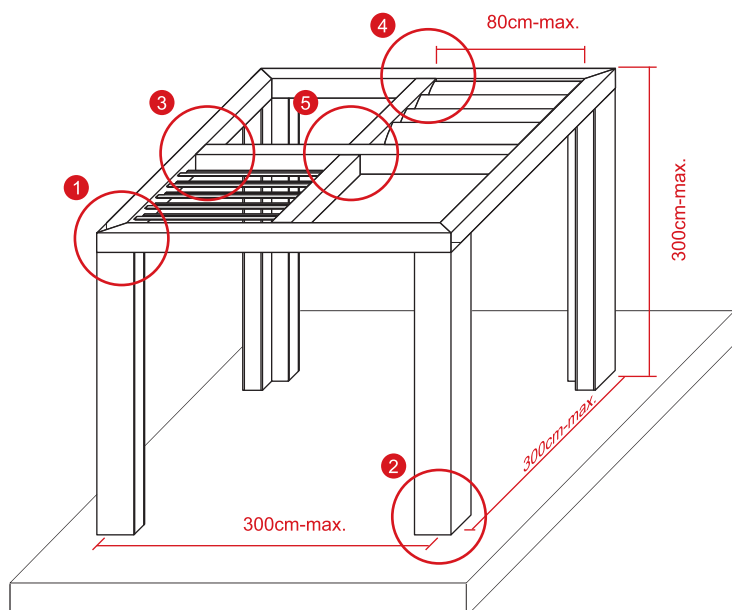

Support of polycarbonate sheet.

Podrška za polikarbonatne ploče.

## Column process - Proces za stub

- 1 Inclination 0°.  
Nagib 0°.

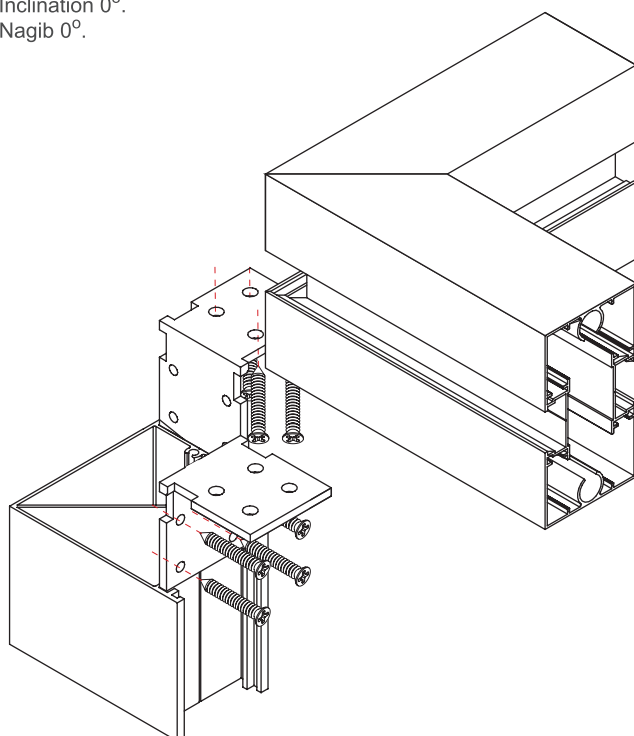

- 2 Column support on the ground.  
Nosac stuba na podu.

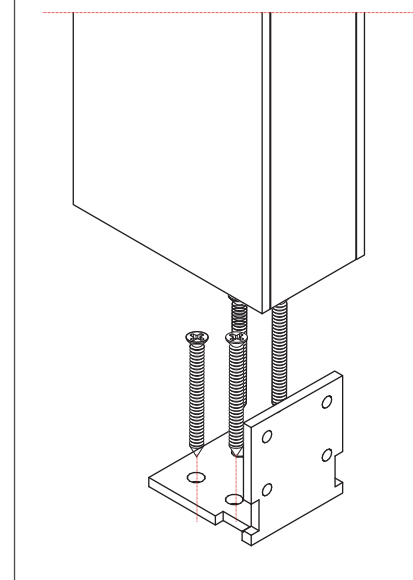



## Installation of louver blades - Montaža žaluzina

[www.aluminco.com](http://www.aluminco.com)

- 3** Installation of movable louver blades.  
Montaža pokretnih žaluzina

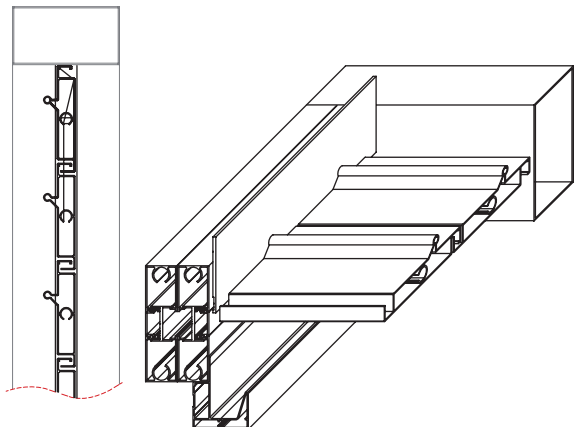

- 4** Installation of fixed louver blades.  
Montaža fiksnih žaluzina.

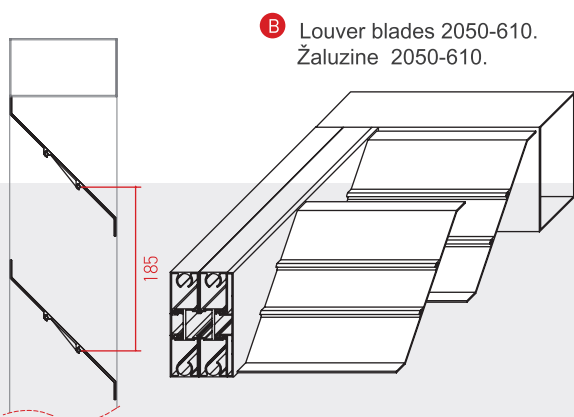
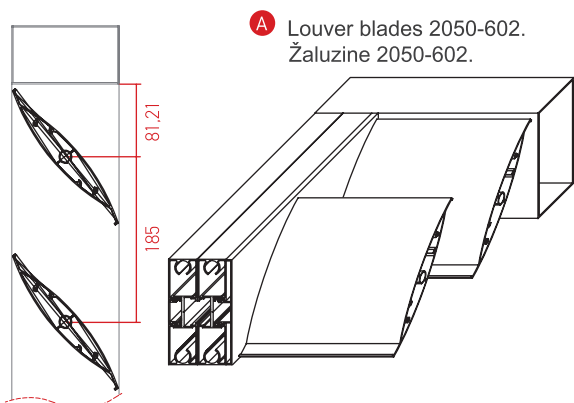

- 5** Transom support.  
Spoj i veza profila.

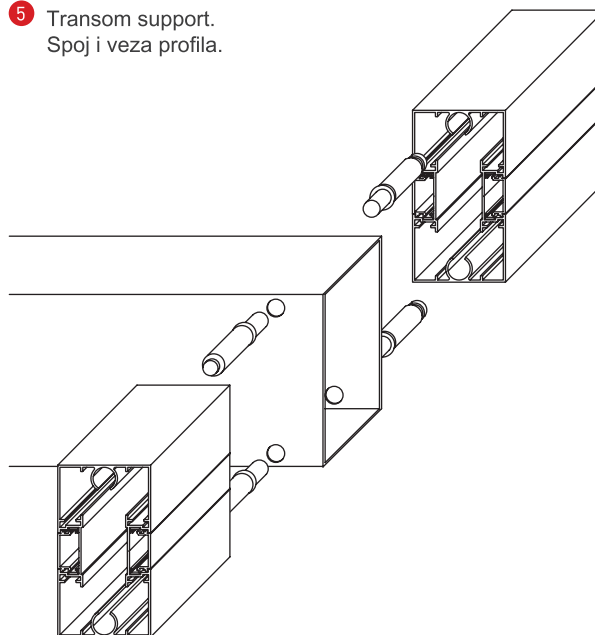

## Polycarbonate sheet support Podrška polikarbonatnih ploča.

- 6** Main transom.  
Centralna podela.

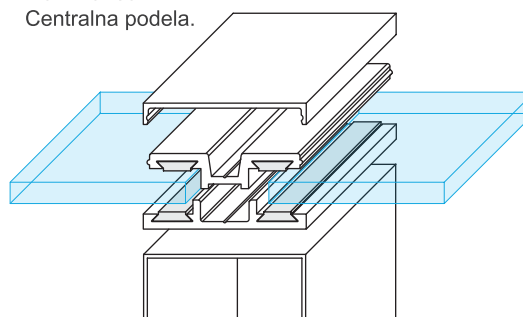

- 7** Transom finishing.  
Završna podela.

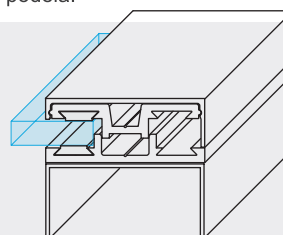

# Aplikacije

## Processing of louver blades - Obrada žaluzina

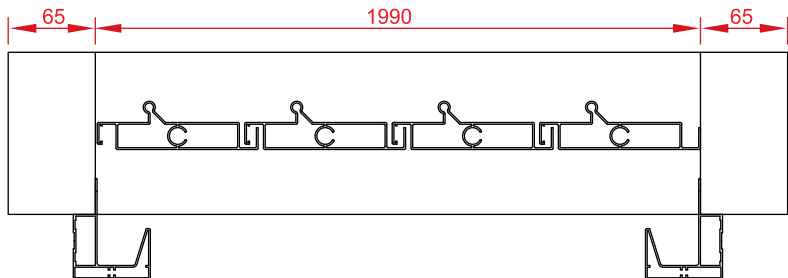

Note: No special processing is required in case A.  
 Napomena: Nije potrebna posebna obrada u slučaju A.

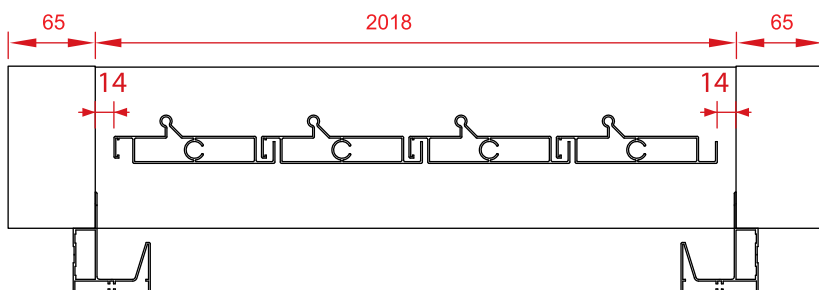

Note: No special processing is required in case B.  
 Napomena: Nije potrebna posebna obrada u slučaju B

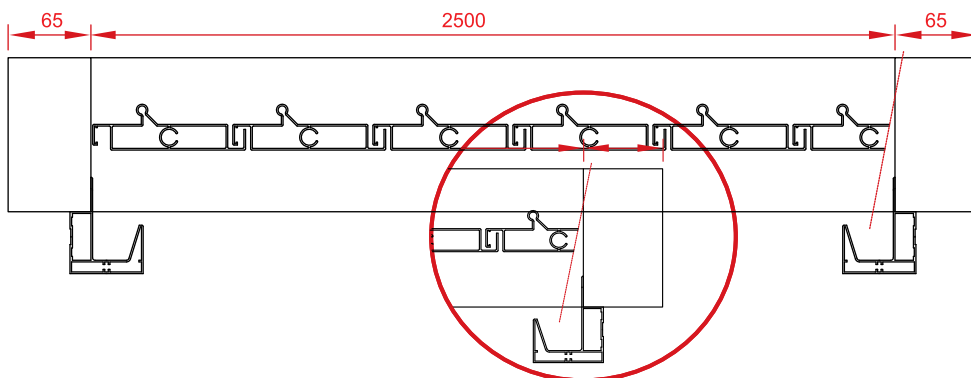

Opening pitch 510-919.  
 Otvaranje rupa 510-919.

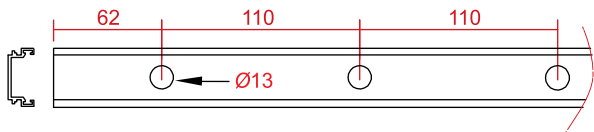

Opening pitch 2050-904.  
 Otvaranje rupa 2050-904.

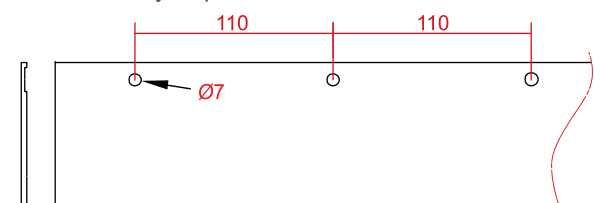

### Case A

Design where louver blades fit exactly to the usable length.

### Slučaj A

Dizajnirati tamo gde žaluzine tačno mogu stati u upotrebnu dužinu.

### Case B

Design where louver blades have a maximum opening of 14mm right and left.

### Slučaj B

Dizajnirati tamo gde žaluzine imaju max. otvor od 14 mm desno i levo.

### Case C

Design where louver blades are in excess on one side.

### Slučaj C

Dizajnirati tamo gde su žaluzine višak s jedne strane.

# Moments of Inertia / Drag Moments



## Momenti Inercije / Otporni Momenti

Information for the maximum dimensions (p. 22-26) is indicative. In order to calculate the loads that pergolas may accept, please consult the moments of inertia given in the following table.

Informacija za maksimalne dimenzije (str. 22-26) je indikativna. Kako bi se izračunalo opterećenje koje pergole mogu prihvatiti, konsultujte **momente inercije** u datoj tabeli.

|          |  | Jxx                        | Jyy                        | Wx                                    | Wy                                    |
|----------|--|----------------------------|----------------------------|---------------------------------------|---------------------------------------|
| 900      | Supporting Column Stub                                 | Jxx=114,70 cm <sup>4</sup> | Jyy=114,70 cm <sup>4</sup> | W <sub>x</sub> =22,94 cm <sup>3</sup> | W <sub>y</sub> =22,94 cm <sup>3</sup> |
| 901      | Supporting Column Stub                                 | Jxx=244,83 cm <sup>4</sup> | Jyy=244,83 cm <sup>4</sup> | W <sub>x</sub> =40,80 cm <sup>3</sup> | W <sub>y</sub> =40,80 cm <sup>3</sup> |
| 59-026   | Horizontal girder<br>Horizontalni nosač                | Jxx=42,25 cm <sup>4</sup>  | Jyy=108,49 cm <sup>4</sup> | W <sub>x</sub> =13,00 cm <sup>3</sup> | W <sub>y</sub> =18,08 cm <sup>3</sup> |
| 59-027   | Purlin<br>Sleme  | Jxx=36,20 cm <sup>4</sup>  | Jyy=70,11 cm <sup>4</sup>  | W <sub>x</sub> =11,13 cm <sup>3</sup> | W <sub>y</sub> =14,02 cm <sup>3</sup> |
| 59-028   | Purlin<br>Sleme  | Jxx=30,15 cm <sup>4</sup>  | Jyy=41,45 cm <sup>4</sup>  | W <sub>x</sub> =9,27 cm <sup>3</sup>  | W <sub>y</sub> =10,36 cm <sup>3</sup> |
| 2050-601 | Movable louver blades<br>Pokretne žaluzine             | Jxx=53,00 cm <sup>4</sup>  | Jyy=4,30 cm <sup>4</sup>   | W <sub>x</sub> =9,19 cm <sup>3</sup>  | W <sub>y</sub> =1,79 cm <sup>3</sup>  |
| 2050-602 | Fixed louver blades<br>Fiksne žaluzine                 | Jxx=171,45 cm <sup>4</sup> | Jyy=5,26 cm <sup>4</sup>   | W <sub>x</sub> =18,09 cm <sup>3</sup> | W <sub>y</sub> =3,60 cm <sup>3</sup>  |
| 2050-610 | Fixed louver blades<br>Fiksne žaluzine                 | Jxx=62,92 cm <sup>4</sup>  | Jyy=72,00 cm <sup>4</sup>  | W <sub>x</sub> =10,50 cm <sup>3</sup> | W <sub>y</sub> =9,10 cm <sup>3</sup>  |
| 970-401  | Transom 120x65<br>Transom 120x65                       | Jxx=153,24 cm <sup>4</sup> | Jyy=48,04 cm <sup>4</sup>  | W <sub>x</sub> =25,54 cm <sup>3</sup> | W <sub>y</sub> =14,78 cm <sup>3</sup> |
| 970-402  | Transom 120x32,5<br>Transom 120x32,5                   | Jxx=109,23 cm <sup>4</sup> | Jyy=8,86 cm <sup>4</sup>   | W <sub>x</sub> =18,20 cm <sup>3</sup> | W <sub>y</sub> =5,45 cm <sup>3</sup>  |
| 970-901  | Base of fixed louver blades<br>Baza za fiksne žaluzine | Jxx=29,01 cm <sup>4</sup>  | Jyy=1,06 cm <sup>4</sup>   | W <sub>x</sub> =4,83 cm <sup>3</sup>  | W <sub>y</sub> =2,37 cm <sup>3</sup>  |
| 970-902  | Drip Sill Profile<br>Profil za drenažu                 | Jxx=14,46 cm <sup>4</sup>  | Jyy=15,76 cm <sup>4</sup>  | W <sub>x</sub> =2,71 cm <sup>3</sup>  | W <sub>y</sub> =4,92 cm <sup>3</sup>  |
| 2050-108 | Corner column<br>Ugaoni stub                           | Jxx=208,82 cm <sup>4</sup> | Jyy=208,80 cm <sup>4</sup> | W <sub>x</sub> =40,10 cm <sup>3</sup> | W <sub>y</sub> =30,73 cm <sup>3</sup> |
| 2050-105 | Column<br>Stub   | Jxx=152,23 cm <sup>4</sup> | Jyy=67,62 cm <sup>4</sup>  | W <sub>x</sub> =25,37 cm <sup>3</sup> | W <sub>y</sub> =20,80 cm <sup>3</sup> |
| 970-903  | Adjustable transom support<br>Podesivi noseći transom  | Jxx=13,51 cm <sup>4</sup>  | Jyy=0,55 cm <sup>4</sup>   | W <sub>x</sub> =2,76 cm <sup>3</sup>  | W <sub>y</sub> =0,52 cm <sup>3</sup>  |
| 970-904  | Transom wall support<br>Zidni noseći transom           | Jxx=175,79 cm <sup>4</sup> | Jyy=39,10 cm <sup>4</sup>  | W <sub>x</sub> =28,30 cm <sup>3</sup> | W <sub>y</sub> =23,50 cm <sup>3</sup> |
| 970-1B1  | Joint supporting base<br>Zajednička noseća baza        | Jxx=0,19 cm <sup>4</sup>   | Jyy=10,12 cm <sup>4</sup>  | W <sub>x</sub> =0,21 cm <sup>3</sup>  | W <sub>y</sub> =3,11 cm <sup>3</sup>  |
| 970-1B2  | Joint supporting base<br>Zajednička noseća baza        | Jxx=0,62 cm <sup>4</sup>   | Jyy=10,57 cm <sup>4</sup>  | W <sub>x</sub> =0,46 cm <sup>3</sup>  | W <sub>y</sub> =3,25 cm <sup>3</sup>  |
| 970-1B5  | Joint supporting base<br>Zajednička noseća baza        | Jxx=0,73 cm <sup>4</sup>   | Jyy=12,03 cm <sup>4</sup>  | W <sub>x</sub> =0,56 cm <sup>3</sup>  | W <sub>y</sub> =3,88 cm <sup>3</sup>  |
| 970-1K1  | Joint cover<br>Zajednički poklopac                     | Jxx=0,04 cm <sup>4</sup>   | Jyy=0,69 cm <sup>4</sup>   | W <sub>x</sub> =0,24 cm <sup>3</sup>  | W <sub>y</sub> =0,21 cm <sup>3</sup>  |
| 970-1K5  | Joint cover<br>Zajednički poklopac                     | Jxx=0,30 cm <sup>4</sup>   | Jyy=8,46 cm <sup>4</sup>   | W <sub>x</sub> =1,04 cm <sup>3</sup>  | W <sub>y</sub> =2,88 cm <sup>3</sup>  |
| 970-1P1  | Joint pressure plate<br>Zajednička pritisna ploča      | Jxx=0,46 cm <sup>4</sup>   | Jyy=8,16 cm <sup>4</sup>   | W <sub>x</sub> =0,94 cm <sup>3</sup>  | W <sub>y</sub> =2,63 cm <sup>3</sup>  |
| 970-1P2  | Joint pressure plate<br>Zajednička pritisna ploča      | Jxx=0,99 cm <sup>4</sup>   | Jyy=8,41 cm <sup>4</sup>   | W <sub>x</sub> =1,57 cm <sup>3</sup>  | W <sub>y</sub> =2,71 cm <sup>3</sup>  |

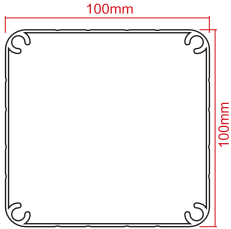
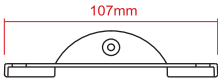
## Profile & Accessories for Traditional Pergola Profili & Prateća oprema za Tradicionalnu Pergolu

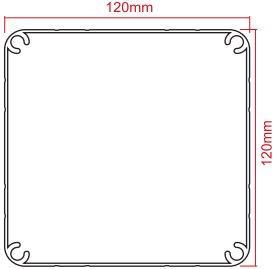
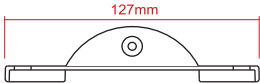
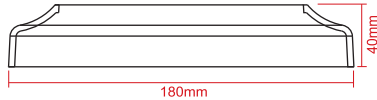
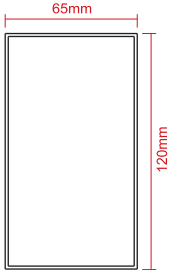
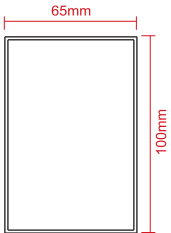
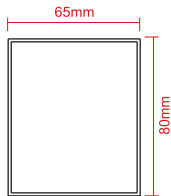
|   |  |  |
|---|--|--|
| <p>Oznaka   Supporting Column<br/><b>900</b>   Stub</p>  <p>Cena: 14,00 €/m<br/>Cena WOOD COLOR : 23,60 €/m</p>                    | <p>Oznaka   Column Cap 900 (100x100mm)<br/><b>272-231</b>   Poklopac za stub 900</p>  <p>Cena: 1,90 €/kom.<br/>Cena WOOD COLOR : 5,90 €/kom.</p>  | <p>Oznaka   Supporting Foot 900 (100x100mm)<br/><b>4104</b>   Stopa za stub 900 (100x100mm)</p>  <p>Cena: 7,50 €/kom.<br/>Cena WOOD COLOR : 14,30 €/kom.</p>  |
| <p>Oznaka   Supporting Column<br/><b>901</b>   Stub</p>  <p>Cena: 19,50 €/m<br/>Cena WOOD COLOR : 33,90 €/m</p>                   | <p>Oznaka   Column Cap 901 (120x120mm)<br/><b>272-230</b>   Poklopac za stub 901</p>  <p>Cena: 2,10 €/kom.<br/>Cena WOOD COLOR : 5,60 €/kom.</p> | <p>Oznaka   Supporting Foot 901 (120x120mm)<br/><b>4105</b>   Stopa za stub 901 (120x120mm)</p>  <p>Cena: 8,50 €/kom.<br/>Cena WOOD COLOR : 16,20 €/kom.</p> |
| <p>Oznaka   Horizontal girder<br/><b>59-026</b>   Horizontalni nosač</p>  <p>Cena: 10,50 €/m<br/>Cena WOOD COLOR : 18,00 €/m</p> | <p>Oznaka   Transom<br/><b>59-027</b>   Transom</p>  <p>Cena: 9,50 €/m<br/>Cena WOOD COLOR : 16,20 €/m</p>                                      | <p>Oznaka   Transom<br/><b>59-028</b>   Transom</p>  <p>Cena: 8,40 €/m<br/>Cena WOOD COLOR : 14,30 €/m</p>  |

|   |  |                                       |                      |
|---|--|---------------------------------------|----------------------|
| <p>Prices for basic colors in white RAL9016 &amp; black RAL9005<br/>Cene za osnovne nijanse belu RAL9016 &amp; crnu RAL9005</p> | <p>Prices for colors<br/>Cena za nijanse</p> | <p>RAL<br/>RAFAELLO - SABLE - MAT</p> | <p>+10%<br/>+15%</p> |
|---|--|---------------------------------------|----------------------|

Oznaka | Transom cap 59-028  
**272-213** | Transom poklopac 59-028

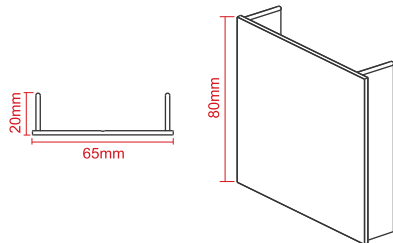

Price: 2,30 €/pcs  
Cena WOOD COLOR : 6,80 €/kom.

Oznaka | Transom cap 59-027  
**272-214** | Transom poklopac 59-027

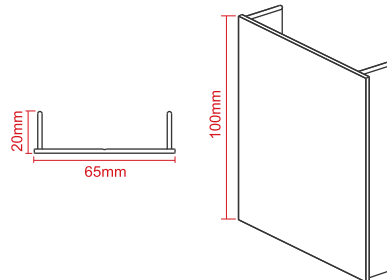

Price: 2,50 €/pcs  
Cena WOOD COLOR : 8,00 €/kom.

Oznaka | Transom cap 59-026  
**272-215** | Transom poklopac 59-028

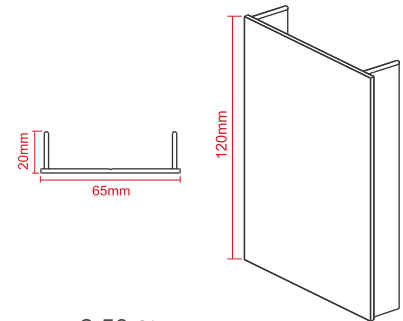

Price: 2,50 €/pcs.  
Cena WOOD COLOR : 9,00 €/kom.

Oznaka | Transom fi nishing 59-028  
**272-210** | Završni transom 59-028

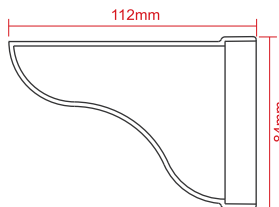

Price: 3,00 €/kom.  
Cena WOOD COLOR : 11,00 €/kom.

Oznaka | Transom fi nishing 59-027  
**272-211** | Završni transom 59-027

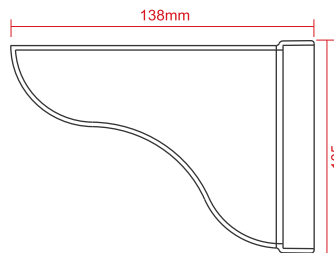

Price: 4,00 €/kom.  
Cena WOOD COLOR : 15,00 €/kom.

Oznaka | Horiz. girder fi nishing 59-026  
**272-212** | Zavr. horizon. nosač 59-026

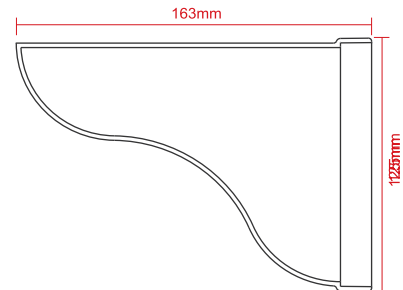

Price: 5,00 €/kom.  
Cena WOOD COLOR : 19,00 €/kom.

Oznaka | Column support 900/901  
**272-200** | Gornji završetak stuba 900/901

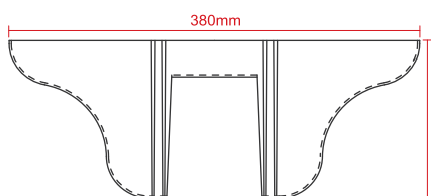

Price: 13,50 €/kom.  
Cena WOOD COLOR : 35,50 €/kom.

Oznaka | Transom sup. foot angle 0-10°  
**272-240** | Stopa za spoj pod uglom 0-10°

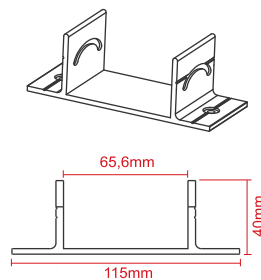

Price: 1,60 €/kom.  
Cena WOOD COLOR : 2,60 €/kom.

Oznaka | Transom sup. foot slope 0-20°  
**272-241** | Stopa za spoj pod uglom 0-20°

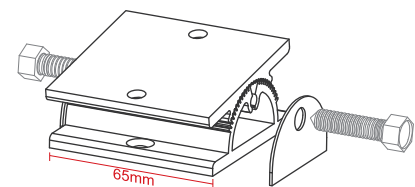

Price: 4,40 €/kom.  
Cena WOOD COLOR : 6,10 €/kom.

Prices for basic colors in white RAL9016 & black RAL9005

Cene za osnovne nijanse bela RAL9016 & crna RAL9005

Prices for colors

Cene za nijanse

RAL

+10%

RAFAELLO - SABLE - MAT

+15%

# Profile of Modern Pergola Profil za Modernu Pergolu

Oznaka | Movable louver blades  
**2050-601** | Pokretne žaluzine

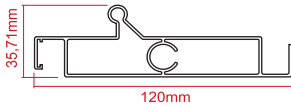

Price: 9,10 €/m  
Cena WOOD COLOR : 15,50 €/m

Oznaka | Louver blades  
**2050-602** | Žaluzine

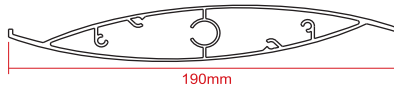

Price: 13,40 €/m  
Cena WOOD COLOR : 22,80 €/m

Oznaka | Fixed louver blades  
**2050-610** | Fiksne žaluzine

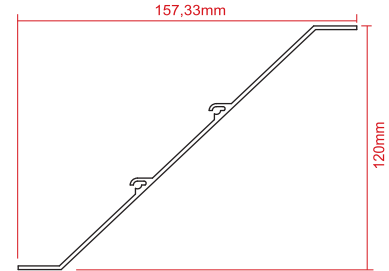

Price: 8,60 €/m  
Cena WOOD COLOR : 14,60 €/m

Oznaka | Transom 120x65  
**970-401** | Transom 120x65

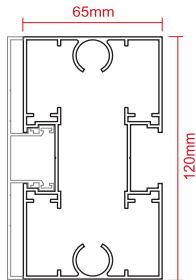

Price: 15,80 €/m  
Cena WOOD COLOR : 29,60 €/m

Oznaka | Transom 120x32,5  
**970-402** | Transom 120x32.5

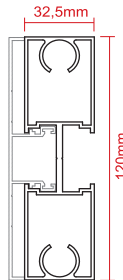

Price: 13,70 €/m  
Cena WOOD COLOR : 23,30 €/m

Oznaka | Base of fixed louver blades  
**970-901** | Baza za fiksne žaluzine

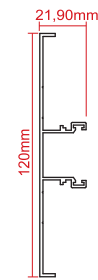

Price: 5,70 €/m  
Cena WOOD COLOR : 9,70 €/m

Oznaka | Transom Cover 970-401/402  
**510-919** | Transom poklopac 970-401/402

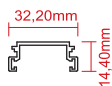

Cena: 5,45 €/kg  
Cena za imitaciju drveta +4,00 €/kg  
RAL, RAFAELLO, MAT: upon agreement - po dogovoru

Oznaka | Transom Cover 970-401/402  
**510-920** | Transom poklopac 970-401/402

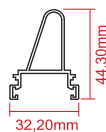

Cena: 5,45 €/kg  
Cena za imitaciju drveta: +4,00 €/kg  
RAL, RAFAELLO, MAT: upon agreement - po dogovoru

Oznaka | Drip Sill Profile  
**970-902** | Profil za drenažu

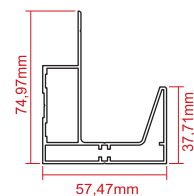

Cena: 8,40 €/m  
Cena za imitaciju drveta : 14,30 €

|   |                   |                        |      |
|---|-------------------|------------------------|------|
| Prices for basic colors in white RAL9016 & black RAL9005<br>Cena za osnovne nijanse bela RAL9016 & crna RAL9005 | Prices for colors | RAL                    | +10% |
|   | Cena za nijanse   | RAFAELLO - SABLE - MAT | +15% |

Code  
**2050-904** | Plate for the movement of the blind  
Profil pločica za kretanje

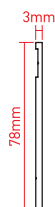

Price: 4,40 €/m  
Cena za imitaciju drveta : 7,50 €/m

Code  
**2050-108** | Corner column  
Ugaoni stub

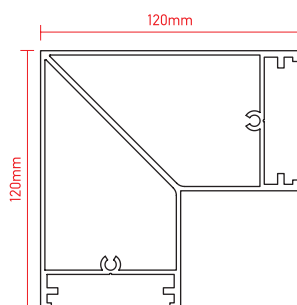

Price: 26,40 €/m  
Price WOOD COLOR : 44,90 €/m

Code  
**2050-105** | Column  
Stub

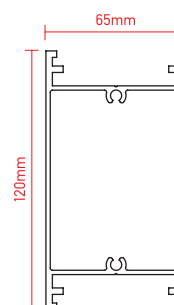

Price: 18,50 €/m  
Price WOOD COLOR : 31,40 €/m

Code  
**2050-1K2** | Column cover 2050-108, 2050-105  
Piklopac stuba 2050-108

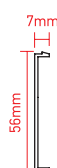

Price: 1,90 €/m  
Price WOOD COLOR : 3,20 €/m

Code  
**970-903** | Adjustable transom support  
Dodatni transom držač

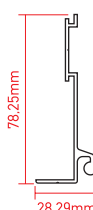

Price: 4,30 €/m  
Price WOOD COLOR : 7,30 €/m

Code  
**970-904** | Transom wall support  
Transom zidni držač

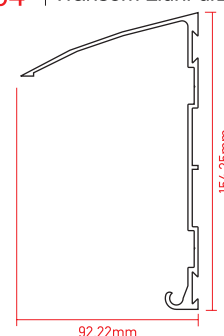

Price: 13,30 €/m  
Price WOOD COLOR : 22,60 €/m

Code  
**410-903** | Annex for rubber seal  
Profil za gumenu zaptivku

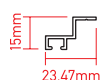



Price: 5,45 €/kg  
Price for wood color: +4,00 €/kg  
RAL, RAFAELLO, MAT:  
upon agreement, po dogovoru

Prices for basic colors in white RAL9016 & black RAL9005  
Cena za osnovne nijanse bela RAL9016 i crna RAL9005

Prices for colors  
Cene za nijanse

|                        |      |
|------------------------|------|
| RAL                    | +10% |
| RAFAELLO - SABLE - MAT | +15% |

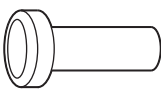
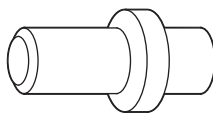
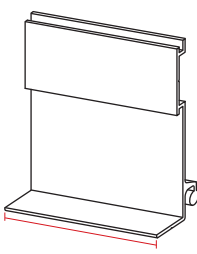
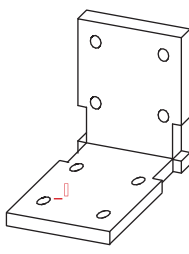
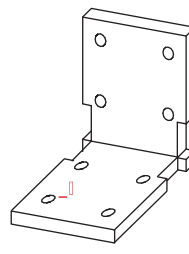
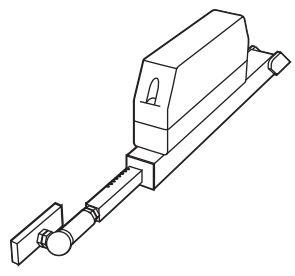
## Accessories for Modern Pergola Prateća oprema za Modernu Pergolu

|  |   |  |
|--|---|--|
| <p>Oznaka   Spring Pin<br/><b>272-242</b>   Klin</p>  <p>Cena: 1,80€/kom.</p>   | <p>Oznaka   Pin for louver blade Ø11<br/><b>272-243</b>   Klin za žaluzine Ø11</p>  <p>Cena: 0,25 €/kom.</p> | <p>Oznaka   Plastic axle of louver blade<br/><b>272-244</b>   Plastična čaura za žaluzine</p>  <p>Cena: 0,20 €/kom.</p> |
| <p>Oznaka   Adjustable support 65mm<br/><b>272-245</b>   Dodatni nosač 65mm</p>  <p>Cena: 1,30€/kom.<br/>Cena za imitaciju drveta : 2,20€/kom.</p> | <p>Oznaka   Column support angle<br/><b>E2050-012</b>   Ugao za noseći stub</p>  <p>Cena: 3,60€/kom.</p>    | <p>Oznaka   Column joint 65mm<br/><b>E2050-022</b>   Stubni spoj 65mm</p>  <p>Cena: 3,60€/kom.</p>                     |
| <p>Oznaka   Motor for the movement of<br/>louvers blades<br/><b>272-300</b>   Motor za pokretne žaluzine</p>  <p>Cena: do ----- €/kom.</p>        | <p>Oznaka   Daljinski upravljač<br/><b>272-301</b></p>  <p>Cena: do ----- €/kom.</p>                       |  |

|   |   |                                       |                      |
|---|---|---------------------------------------|----------------------|
| <p>Prices for basic colors in white RAL9016 &amp; black RAL9005<br/>Cene osnovnih nijansi bela RAL9016 &amp; crna RAL9005</p> | <p>Prices for colors<br/>Cene nijansi</p> | <p>RAL<br/>RAFAELLO - SABLE - MAT</p> | <p>+10%<br/>+15%</p> |
|---|---|---------------------------------------|----------------------|



# Polycarbonate sheet support system Noseći sistem sa polikarbonatnim pločama

www.aluminco.com

Ceiling support system, heavy duty  
Krovni noseći sistem, teski

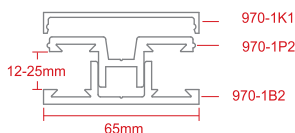

**970-1K1**  
Joint cover  
Poklopac  
Cena: 3,10 €/m  
Cena imitacije drveta : 5,20 €/m

**970-1P2**  
Joint pressure plate  
Pločica  
Cena: 6,50 €/m  
Cena imitacije drveta : 11,00 €/m

**970-1B2**  
Joint supporting base  
Noseća ugaona baza  
Cena: 6,30 €/m  
Cena imitacije drveta : 10,70 €/m

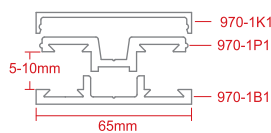

**970-1K1**  
Joint cover  
Poklopac  
Cena: 3,10 €/m  
Cena imitacije drveta : 5,20 €/m

**970-1P1**  
Joint pressure plate  
Pločica  
Cena: 5,90 €/m  
Cena imitacije drveta : 10,00 €/m

**970-1B1**  
Joint supporting base  
Noseća ugaona baza  
Cena: 5,60 €/m  
Cena imitacije drveta : 9,50 €/m

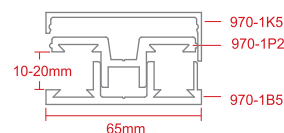

**970-1K5**  
Joint cover  
Poklopac  
Cena: 3,40 €/m  
Cena imitacije drveta : 5,70 €/m

**970-1P2**  
Joint pressure plate  
Pločica  
Cena: 6,50 €/m  
Cena imitacije drveta : 11,00 €/m

**970-1B5**  
Joint supporting base  
Noseća ugaona baza  
Cena: 6,70 €/m  
Cena imitacije drveta : 11,30 €/m

Ceiling support system, light-duty  
Krovni noseći sistem, lagani

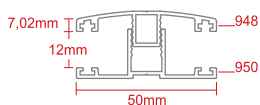

**948**  
Joint cover  
Poklopac za ugao  
Cena: 2,50 €/m  
Cena za imitaciju drveta : 4,20 €/m

**950**  
Joint supporting base  
Noseći ugao  
Cena: 2,50 €/m  
Cena za imitaciju drveta : 4,20 €/m

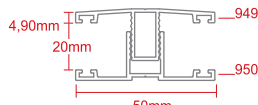

**949**  
Joint cover  
Poklopac za ugao  
Cena: 2,60 €/m  
Cena za imitaciju drveta : 4,40 €/m

**950**  
Joint supporting base  
Noseći ugao  
Cena: 2,50 €/m  
Cena za imitaciju drveta : 4,20 €/m

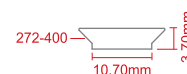

**272-400**  
EPDM rubber for pro les  
970-1P1/1P2/1B1/1B2/1B5  
EPDM guma za pro le  
970-1P1/1P2/1B1/1B2/1B5  
Cena: 0,54 €/m

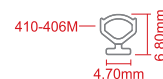

**410-406M**  
Rubber seal for profiles 948/949/950  
Zaptivna guma za profi le 948/949/950  
Cena: -----€/m

Supporting profile "F" for multiwall polycarbonate sheets  
Završni "F" profil za polikarbonatne ploče

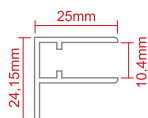

**970-F10**  
Cena: 2,20 €/m  
Cena imitacije drveta : 3,70 €/m

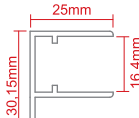

**970-F16**  
Cena: 2,40 €/m  
Cena imitacije drveta : 4,10 €/m

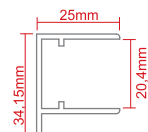

**970-F20**  
Cena: 2,50 €/m  
Cena imitacije drveta: 4,20 €/m

|  |                   |                        |      |
|--|-------------------|------------------------|------|
| Prices for basic colors in white RAL9016 & black RAL9005<br>Cene za osnovne boje bela RAL9016 i crna RAL9005 | Prices for colors | RAL                    | +10% |
|  | Cene nijansi      | RAFAELLO - SABLE - MAT | +15% |

**ALUMINCO<sup>®</sup>**

**A ALUMINIUM BUILDING SYSTEMS**

# Pricelist

DOOR  
PANELS



# KOMBINACIJA PANELA SA DIMENZIJAMA

P100 Series

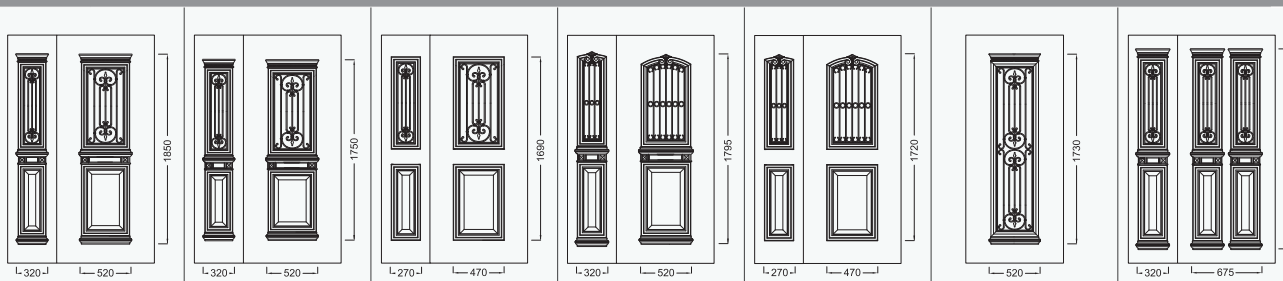

I300 Series

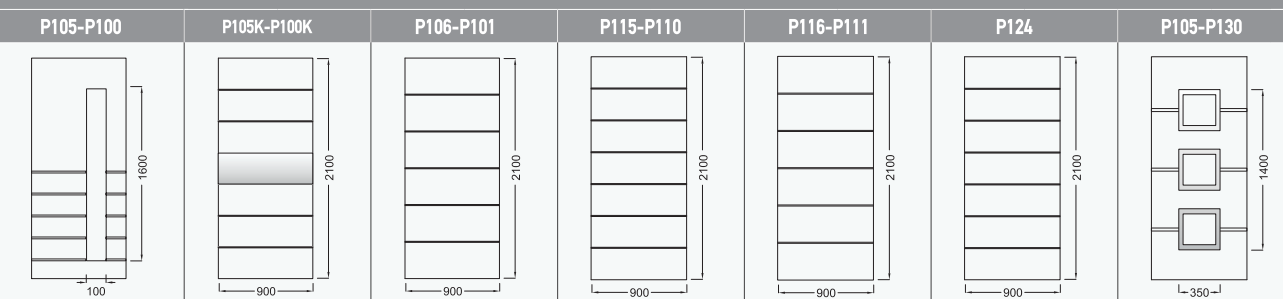

I221

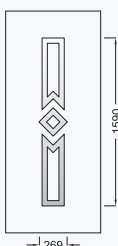

I320



I224

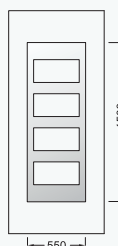

I325

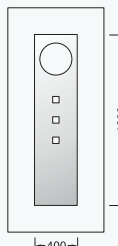

I225



I330

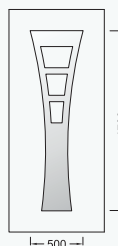

I226

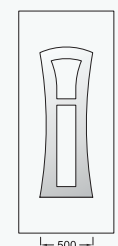

I335

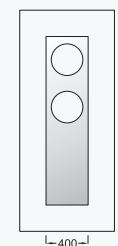

I235

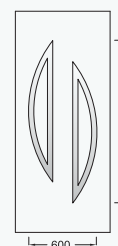

I340

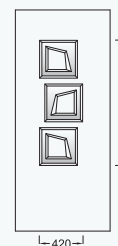

I236

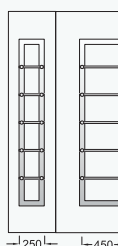

I383-I343

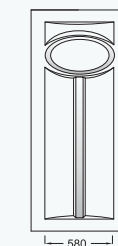

I240

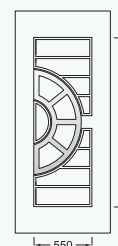

I345

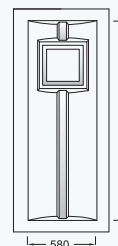

E2000 Series

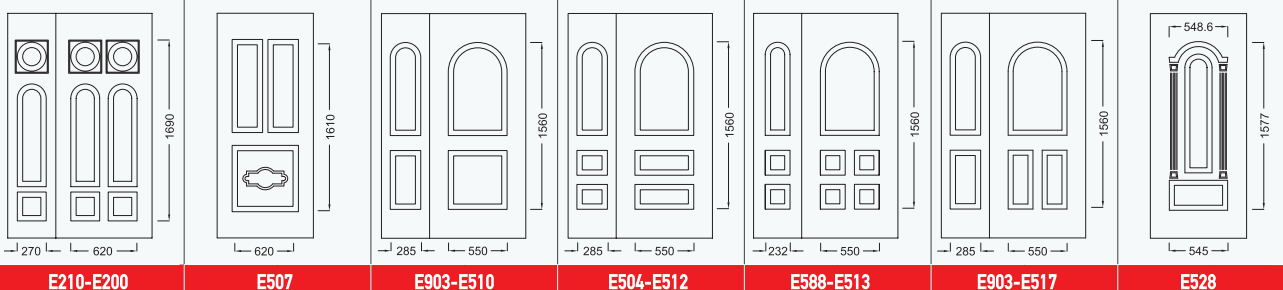

E210-E200

E507

E903-E510

E504-E512

E588-E513

E903-E517







E528

Aluglobe  
katalog sa  
cenovnikom  
2013

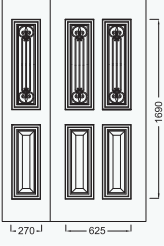
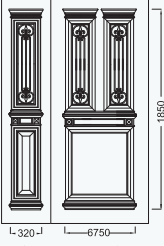
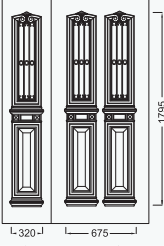
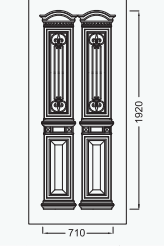
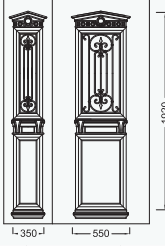
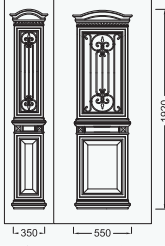
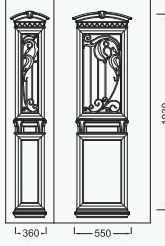
66

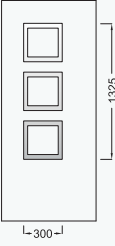
AluGlobe.

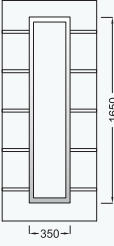
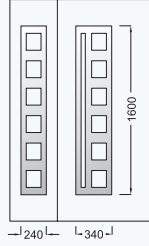
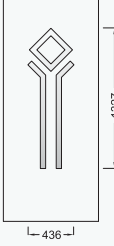
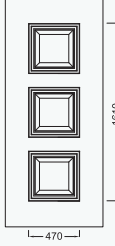
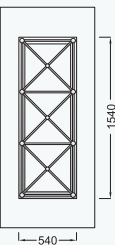
# KOMBINACIJA PANELA SA DIMENZIJAMA

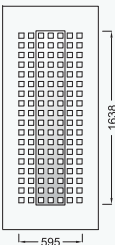
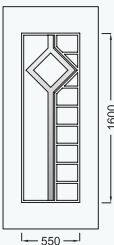
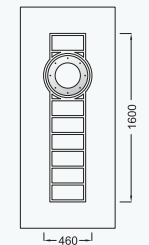
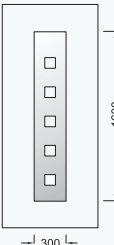
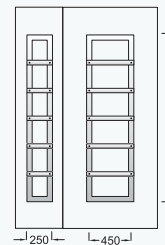
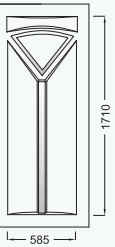
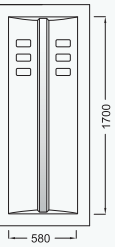
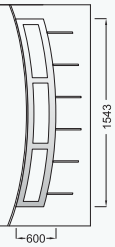
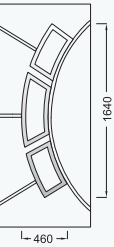
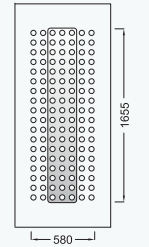
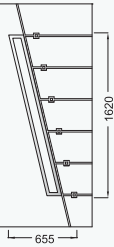
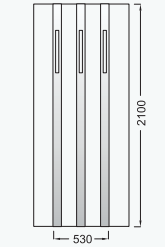
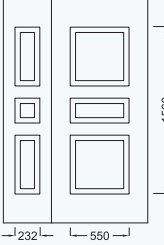
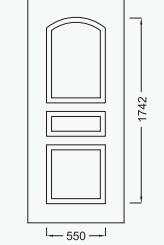
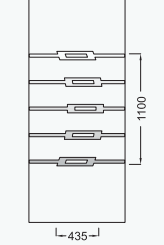
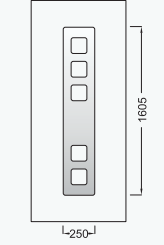
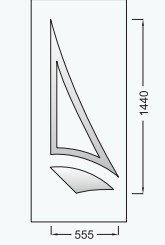
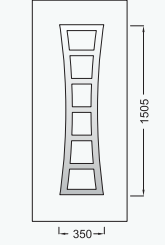
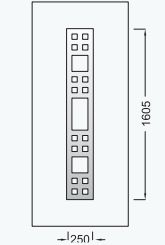
|   |   |   |   |  |   |   |
|---|---|---|---|--|---|---|
|    |    |    |    |    |    |    |
| P106-P131   | P105-P136   | P115-P140   | P164  | P138-P168  | P177-P176   | P129-P189   |
|    |    |    |    |    |    |    |
| I245  | I250  | I260  | I270  | I313-I300  | I310  | P190  |
|   |   |   |   |   |   |   |
| I347  | I350  | I357  | I362  | I372   | I375  | I388-I378   |
|  |  |  |  |  |  |  |
| I415  | I417  | I420  | I425  | I429   | I450  | I455  |
|  |  |  |  |  |  |  |
| E810-E530   | E532  | I460  | I465  | I480   | I490  | I495  |

# KOMBINACIJE PANELA SA DIMENZIJAMA

**E2000 Series**

|                  |                    |                    |                  |                  |                  |                    |
|------------------|--------------------|--------------------|------------------|------------------|------------------|--------------------|
|                  |                    |                    |                  |                  |                  |                    |
| <b>E534</b>      | <b>E536</b>        | <b>E554-E540</b>   | <b>E545</b>      | <b>E547</b>      | <b>E504-E550</b> | <b>E907-E552</b>   |
|                  |                    |                    |                  |                  |                  |                    |
| <b>E710</b>      | <b>E714</b>        | <b>E720</b>        | <b>E986-E725</b> | <b>E728</b>      | <b>E740</b>      | <b>E750</b>        |
|                  |                    |                    |                  |                  |                  |                    |
| <b>E785</b>      | <b>E789</b>        | <b>E790</b>        | <b>E800-E803</b> | <b>E810-E812</b> | <b>E520-E820</b> | <b>E845</b>        |
|                  |                    |                    |                  |                  |                  |                    |
| <b>E562-E884</b> | <b>E892-E895</b>   | <b>E897</b>        | <b>E903-E902</b> | <b>E903-E910</b> | <b>E922</b>      | <b>E933-E926</b>   |
|                  |                    |                    |                  |                  |                  |                    |
| <b>P6120</b>     | <b>P6630-P6130</b> | <b>P6750-P6140</b> | <b>P6150</b>     | <b>P6160</b>     | <b>P6170</b>     | <b>P6680-P6180</b> |







**P6000 Series**

Aluglobe  
katalog sa  
cenovnikom  
2013

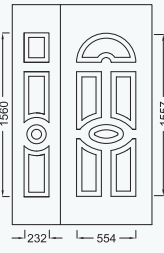
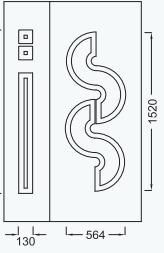
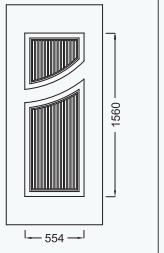
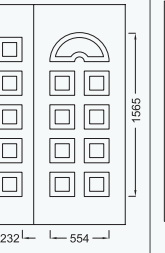
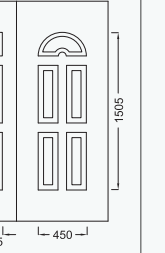
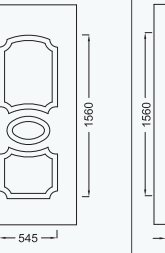
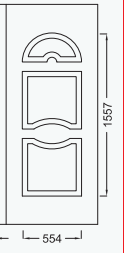
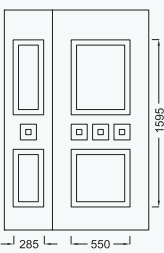
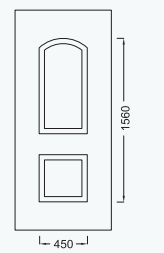
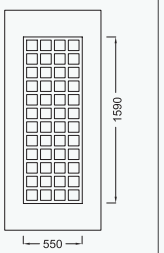
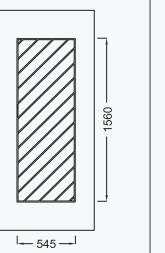
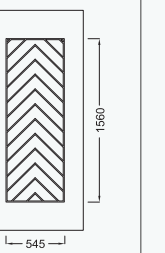
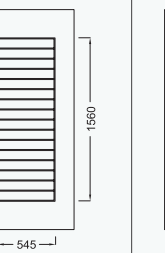
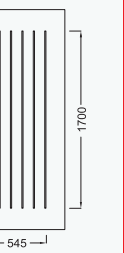
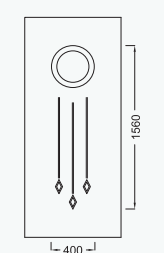
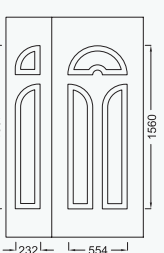
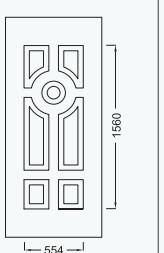
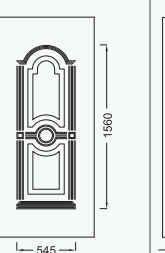
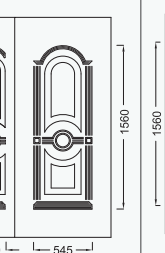
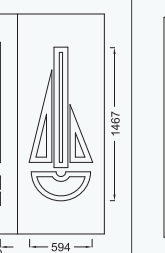
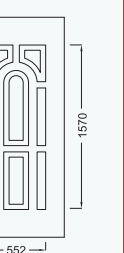
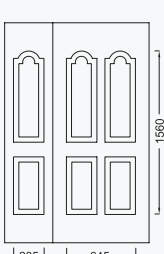
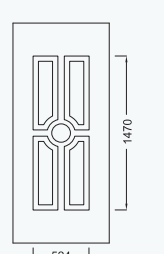
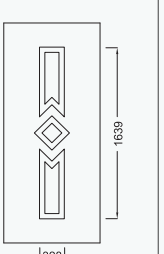
68

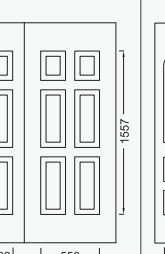
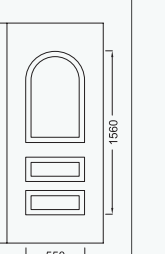
AluGlobe.

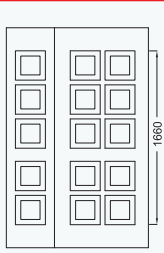
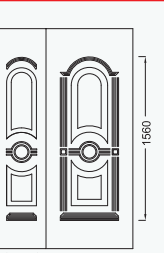
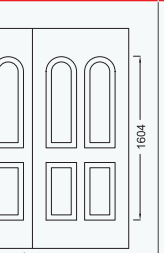
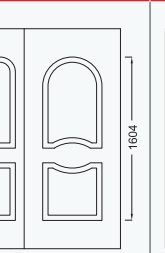
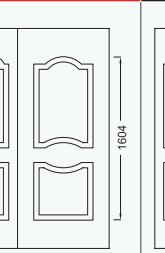
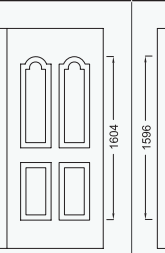
# KOMBINACIJE PANELA SA DIMENZIJAMA

|   |   |   |   |  |   |   |
|---|---|---|---|--|---|---|
|    |    |    |    |    |    |    |
| <b>E856-E556</b>  | <b>E562-E560</b>  | <b>E564</b>   | <b>E572-E566</b>  | <b>E590-E580</b>   | <b>E586</b>   | <b>E986-E700</b>  |
|    |    |    |    |    |    |    |
| <b>E762-E760</b>  | <b>E770</b>   | <b>E780</b>   | <b>E781</b>   | <b>E782</b>  | <b>E783</b>   | <b>E784</b>   |
|   |   |   |   |   |   |   |
| <b>E847</b>   | <b>E854-E850</b>  | <b>E860</b>   | <b>E870</b>   | <b>E865-E873</b>   | <b>E562-E875</b>  | <b>E880</b>   |
|  |  |  |  |  |  |  |
| <b>E933-E941</b>  | <b>E951</b>   | <b>E957</b>   | <b>E986-E982</b>  | <b>E986-E990</b>   | <b>P6600-P6100</b>  | <b>P6110</b>  |
|  |  |  |  |  |  |  |
| <b>P6690-6190</b>   | <b>P6700-P6200</b>  | <b>P6710-P6210</b>  | <b>P6710-P6220</b>  | <b>P6740-P6230</b>   | <b>P6740-P6240</b>  | <b>P6750-P6250</b>  |

- Innovative design
- Double glazing
- Fused glazing with Inox for extra resistance and high aesthetics
- Exceptional heat and sound insulation coefficient
- Certified powder coatings and wood imitation shades

- Inovativan dizajn
- Dvostruko staklo
- Fuziono staklo sa INOX detaljima za posebnu otpornost sa izuzetnim estetskim efektom\*
- Visok stepen toplotne i zvučne izolacije
- Sertifikovane boje za panele i folije u drvo dezenu

|   |
|---|
| DEBLJINA AL LIMA<br>ALUMINIUM SHEET THICKNESS   |
| 1,4 mm  |
| UKUPNA DEBLJINA PANELA<br>TOTAL PANEL THICKNESS   |
| 24 mm   |
| RAZDVAJANJE UKRASNE LAJSNE<br>OD POVRŠINE PANELA<br>FRAME DETACHMENT FROM PANEL<br>SURFACE                        |
| 50,02 Pa/mm <sup>2</sup>  |
| RAZDVAJANJE ALUMINIJUMSKOG LIMA<br>OD TERMOIZOLACIONOG MATERIJALA<br>SHEET DETACHMENT FROM<br>INSULATION MATERIAL |
| 0,488 N/mm <sup>2</sup>   |
| KOEFICIJENAT TOPLLOTNE OTPORNOSTI<br>THERMAL RESISTANCE COEFFICIENT   |
| $RD = m^2 * K/W = 0,55$   |
| KOEFICIJENAT TOPLLOTNE<br>PROVODLJIVOSTI<br>THERMAL CONDUCTIVITY COEFFICIENT                                      |
| $\lambda d = W/M * K = 0,035$   |

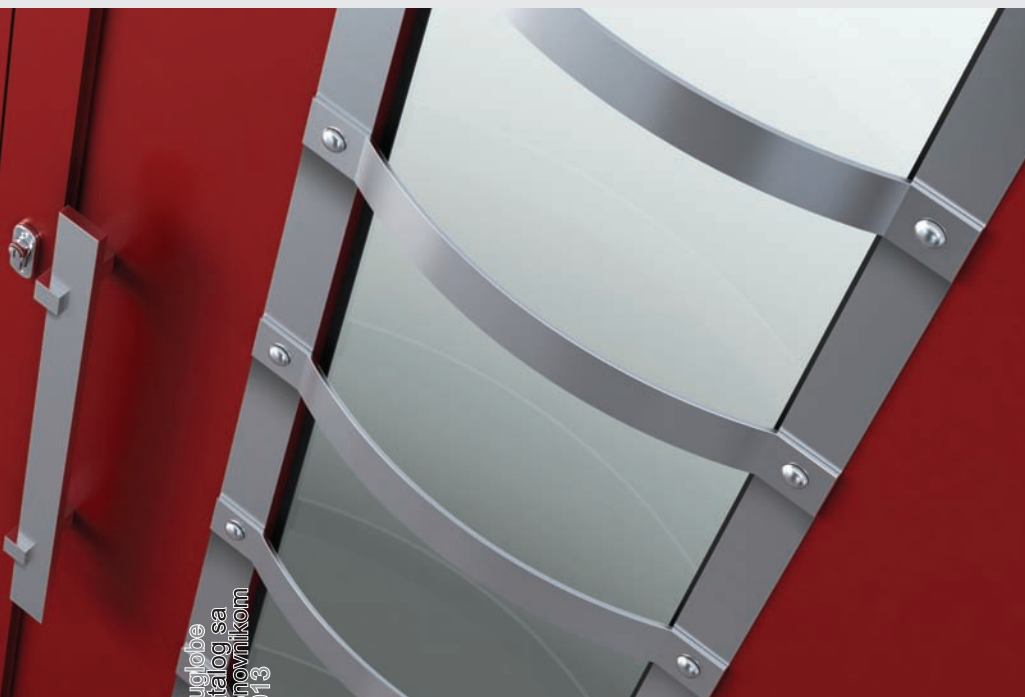

| CODE | GLASSES VITRAGES | DESCRIPTION                  | PRICE PRIX |
|------|------------------|------------------------------|------------|
| I220 |                  | BLIND / PLEIN                | 355 €      |
| I221 | 1                | GLASS / VITRAGE CATHEDRAL    | 420 €      |
| I221 | 1                | GLASS / VITRAGE SANDBLAST    | 440 €      |
| I221 | 1                | GLASS / VITRAGE SUPER SILVER | 471 €      |



| CODE | GLASSES VITRAGES | DESCRIPTION   | PRICE PRIX |
|------|------------------|---------------|------------|
| I236 |                  | BLIND / PLEIN | 300 €      |



| CODE | GLASSES VITRAGES | DESCRIPTION   | PRICE PRIX |
|------|------------------|---------------|------------|
| I224 |                  | BLIND / PLEIN | 585 €      |



| CODE | GLASSES VITRAGES | DESCRIPTION                  | PRICE PRIX |
|------|------------------|------------------------------|------------|
| I240 |                  | BLIND / PLEIN                | 425 €      |
| I241 | 1                | GLASS / VITRAGE DECO         | 445 €      |
| I241 | 1                | GLASS / VITRAGE CATHEDRAL    | 440 €      |
| I241 | 1                | GLASS / VITRAGE SANDBLAST    | 450 €      |
| I241 | 1                | GLASS / VITRAGE SUPER SILVER | 473 €      |
| I242 | 2                | GLASS / VITRAGE DECO         | 465 €      |
| I242 | 2                | GLASS / VITRAGE CATHEDRAL    | 450 €      |
| I242 | 2                | GLASS / VITRAGE SANDBLAST    | 475 €      |
| I242 | 2                | GLASS / VITRAGE SUPER SILVER | 526 €      |
| I243 | 3                | GLASS / VITRAGE DECO         | 485 €      |
| I243 | 3                | GLASS / VITRAGE CATHEDRAL    | 465 €      |
| I243 | 3                | GLASS / VITRAGE SANDBLAST    | 500 €      |
| I243 | 3                | GLASS / VITRAGE SUPER SILVER | 573 €      |



| CODE | GLASSES VITRAGES | DESCRIPTION   | PRICE PRIX |
|------|------------------|---------------|------------|
| I225 |                  | BLIND / PLEIN | 350 €      |



| CODE | GLASSES VITRAGES | DESCRIPTION   | PRICE PRIX |
|------|------------------|---------------|------------|
| I245 |                  | BLIND / PLEIN | 380 €      |



| CODE | GLASSES VITRAGES | DESCRIPTION   | PRICE PRIX |
|------|------------------|---------------|------------|
| I226 |                  | BLIND / PLEIN | 370 €      |



| CODE | GLASSES VITRAGES | DESCRIPTION                  | PRICE PRIX |
|------|------------------|------------------------------|------------|
| I250 |                  | BLIND / PLEIN                | 425 €      |
| I251 | 1                | GLASS / VITRAGE DECO         | 435 €      |
| I251 | 1                | GLASS / VITRAGE SANDBLAST    | 440 €      |
| I251 | 1                | GLASS / VITRAGE SUPER SILVER | 462 €      |
| I252 | 2                | GLASS / VITRAGE DECO         | 455 €      |
| I252 | 2                | GLASS / VITRAGE SANDBLAST    | 465 €      |
| I252 | 2                | GLASS / VITRAGE SUPER SILVER | 514 €      |
| I253 | 3                | GLASS / VITRAGE DECO         | 475 €      |
| I253 | 3                | GLASS / VITRAGE SANDBLAST    | 490 €      |
| I253 | 3                | GLASS / VITRAGE SUPER SILVER | 561 €      |



| CODE | GLASSES VITRAGES | DESCRIPTION                  | PRICE PRIX |
|------|------------------|------------------------------|------------|
| I260 |                  | BLIND / PLEIN                | 450 €      |
| I261 | 1                | GLASS / VITRAGE DECO         | 500 €      |
| I261 | 1                | GLASS / VITRAGE SANDBLAST    | 505 €      |
| I261 | 1                | GLASS / VITRAGE SUPER SILVER | 536 €      |
| I263 | 3                | GLASS / VITRAGE DECO         | 540 €      |
| I263 | 3                | GLASS / VITRAGE SANDBLAST    | 550 €      |
| I263 | 3                | GLASS / VITRAGE SUPER SILVER | 639 €      |



| CODE | GLASSES VITRAGES | DESCRIPTION   | PRICE PRIX |
|------|------------------|---------------|------------|
| I235 |                  | BLIND / PLEIN | 280 €      |



BLIND / PLEIN= puna vrata  
 TRANSOM = sa prečkama  
 VITRO= bojeno staklo  
 SAFETY= INOX detalji  
 FUSED= izliveno  
 DECO= dekor  
 CATHEDRAL= katedral  
 SANDBLAST= peskareno  
 SUPER SILVER= sivi stopslol

For decorative panel with safety inox, add the letter "M" at the end of the code, i.e. I395M  
 Za dekorativne INOX detalje, dodati slovo «M» na kraju šifre, npr. I395M

GLASS / STAKLO KATEDRAL: WHITE/BELO, RED/CRVENO, BLUE/PLAVO, YELLOW/ŽUTO  
 GLASS / STAKLO: WHITE/BELO, RED/CRVENO, BLUE/PLAVO



| CODE | GLASSES broj stakala | DESCRIPTION - OPIS            | PRICE CENA |
|------|----------------------|-------------------------------|------------|
| I325 |                      | BLIND / PLEIN                 | 290 €      |
| I326 | 1                    | GLASS / VITRAGE CATHEDRAL     | 335 €      |
| I326 | 1                    | GLASS / VITRAGE FUSED / VITRO | 445 €      |
| I327 | 2                    | GLASS / VITRAGE CATHEDRAL     | 390 €      |
| I327 | 2                    | GLASS / VITRAGE FUSED / VITRO | 520 €      |
| I328 | 3                    | GLASS / VITRAGE CATHEDRAL     | 440 €      |
| I328 | 3                    | GLASS / VITRAGE FUSED / VITRO | 595 €      |
| I329 | 4                    | GLASS / VITRAGE CATHEDRAL     | 490 €      |
| I329 | 4                    | GLASS / VITRAGE FUSED / VITRO | 670 €      |



| CODE | GLASSES broj stakala | DESCRIPTION - OPIS           | PRICE CENA |
|------|----------------------|------------------------------|------------|
| I270 |                      | BLIND / PLEIN                | 440 €      |
| I271 | 1                    | GLASS / VITRAGE DECO         | 480 €      |
| I271 | 1                    | GLASS / VITRAGE SANDBLAST    | 495 €      |
| I271 | 1                    | GLASS / VITRAGE SUPER SILVER | 526 €      |

| CODE | GLASSES broj stakala | DESCRIPTION - OPIS        | PRICE CENA |
|------|----------------------|---------------------------|------------|
| I330 |                      | BLIND / PLEIN             | 290 €      |
| I331 | 1                    | GLASS / VITRAGE CATHEDRAL | 335 €      |
| I331 | 1                    | GLASS / VITRAGE FUSED     | 415 €      |



| CODE | GLASSES broj stakala | DESCRIPTION - OPIS        | PRICE CENA |
|------|----------------------|---------------------------|------------|
| I300 |                      | BLIND / PLEIN             | 290 €      |
| I301 | 1                    | GLASS / VITRAGE CATHEDRAL | 330 €      |
| I301 | 1                    | GLASS / VITRAGE FUSED     | 440 €      |
| I302 | 2                    | GLASS / VITRAGE CATHEDRAL | 365 €      |
| I302 | 2                    | GLASS / VITRAGE FUSED     | 479 €      |
| I303 | 3                    | GLASS / VITRAGE CATHEDRAL | 395 €      |
| I303 | 3                    | GLASS / VITRAGE FUSED     | 515 €      |
| I304 | 4                    | GLASS / VITRAGE CATHEDRAL | 425 €      |
| I304 | 4                    | GLASS / VITRAGE FUSED     | 550 €      |
| I305 | 5                    | GLASS / VITRAGE CATHEDRAL | 450 €      |
| I305 | 5                    | GLASS / VITRAGE FUSED     | 590 €      |
| I306 | 6                    | GLASS / VITRAGE CATHEDRAL | 485 €      |
| I306 | 6                    | GLASS / VITRAGE FUSED     | 625 €      |
| I307 | 7                    | GLASS / VITRAGE CATHEDRAL | 515 €      |
| I307 | 7                    | GLASS / VITRAGE FUSED     | 665 €      |

| CODE | GLASSES broj stakala | DESCRIPTION - OPIS        | PRICE CENA |
|------|----------------------|---------------------------|------------|
| 335  |                      | BLIND / PLEIN             | 290 €      |
| 336  | 1                    | GLASS / VITRAGE CATHEDRAL | 335 €      |
| 336  | 1                    | GLASS / VITRAGE FUSED     | 415 €      |
| 337  | 2                    | GLASS / VITRAGE CATHEDRAL | 395 €      |
| 337  | 2                    | GLASS / VITRAGE FUSED     | 565 €      |

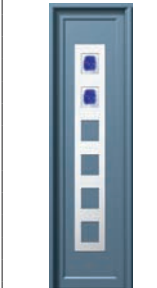

| CODE | GLASSES broj stakala | DESCRIPTION - OPIS        | PRICE CENA |
|------|----------------------|---------------------------|------------|
| I313 |                      | BLIND / PLEIN             | 200 €      |
| I314 | 1                    | GLASS / VITRAGE CATHEDRAL | 225 €      |
| I314 | 1                    | GLASS / VITRAGE FUSED     | 245 €      |
| I315 | 2                    | GLASS / VITRAGE CATHEDRAL | 255 €      |
| I315 | 2                    | GLASS / VITRAGE FUSED     | 290 €      |
| I316 | 3                    | GLASS / VITRAGE CATHEDRAL | 285 €      |
| I316 | 3                    | GLASS / VITRAGE FUSED     | 335 €      |
| I317 | 4                    | GLASS / VITRAGE CATHEDRAL | 315 €      |
| I317 | 4                    | GLASS / VITRAGE FUSED     | 380 €      |
| I318 | 5                    | GLASS / VITRAGE CATHEDRAL | 345 €      |
| I318 | 5                    | GLASS / VITRAGE FUSED     | 425 €      |
| I319 | 6                    | GLASS / VITRAGE CATHEDRAL | 375 €      |
| I319 | 6                    | GLASS / VITRAGE FUSED     | 470 €      |

| CODE | GLASSES broj stakala | DESCRIPTION - OPIS        | PRICE CENA |
|------|----------------------|---------------------------|------------|
| I340 |                      | BLIND / PLEIN             | 290 €      |
| I342 | 2                    | GLASS / VITRAGE CATHEDRAL | 445 €      |
| I342 | 2                    | GLASS / VITRAGE FUSED     | 685 €      |



| CODE | GLASSES broj stakala | DESCRIPTION - OPIS        | PRICE CENA |
|------|----------------------|---------------------------|------------|
| I310 |                      | BLIND / PLEIN             | 290 €      |
| I311 | 1                    | GLASS / VITRAGE CATHEDRAL | 335 €      |
| I311 | 1                    | GLASS / VITRAGE FUSED     | 415 €      |

| CODE | GLASSES broj stakala | DESCRIPTION - OPIS           | PRICE CENA |
|------|----------------------|------------------------------|------------|
| I343 |                      | BLIND / PLEIN                | 365 €      |
| I344 | 1                    | GLASS / VITRAGE CATHEDRAL    | 415 €      |
| I344 | 1                    | GLASS / VITRAGE SANDBLAST    | 425 €      |
| I344 | 1                    | GLASS / VITRAGE SUPER SILVER | 467 €      |



| CODE | GLASSES broj stakala | DESCRIPTION - OPIS        | PRICE CENA |
|------|----------------------|---------------------------|------------|
| I320 |                      | BLIND / PLEIN             | 290 €      |
| I321 | 1                    | GLASS / VITRAGE CATHEDRAL | 337 €      |
| I321 | 1                    | GLASS / VITRAGE FUSED     | 445 €      |
| I322 | 2                    | GLASS / VITRAGE CATHEDRAL | 360 €      |
| I322 | 2                    | GLASS / VITRAGE FUSED     | 490 €      |
| I323 | 3                    | GLASS / VITRAGE CATHEDRAL | 395 €      |
| I323 | 3                    | GLASS / VITRAGE FUSED     | 640 €      |

BLIND / PLEIN= puna vrata  
 TRANSOM = sa prečkama  
 VITRO= bojeno staklo  
 SAFETY= INOX detalji  
 FUSED= izliveno  
 DECO= dekorativno  
 CATHEDRAL= katedral  
 SANDBLAST= peskareno  
 SUPER SILVER=sivi stposl

Aluglobe  
 katalog sa  
 cenovnikom  
 2013

72

For decorative panel with safety inox, add the letter "M" at the end of the code, i.e. I395M  
 Za dekorativne INOX detalje, dodati slovo «M» na kraju šifre, npr. I395M

GLASS / STAKLO KATEDRAL: WHITE/BELO, RED/CRVENO, BLUE/PLAVO, YELLOW/ŽUTO  
 GLASS / STAKLO: WHITE/BELO, RED/CRVENO, BLUE/PLAVO

| CODE | GLASSES broj stakala | DESCRIPTION - OPIS           | PRICE CENA |
|------|----------------------|------------------------------|------------|
| I383 |                      | BLIND / PLEIN                | 285 €      |
| I384 | 1                    | GLASS / VITRAGE CATHEDRAL    | 305 €      |
| I384 | 1                    | GLASS / VITRAGE SANDBLAST    | 315 €      |
| I384 | 1                    | GLASS / VITRAGE SUPER SILVER | 353 €      |

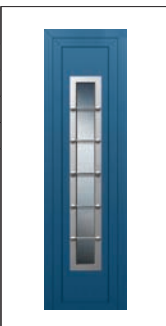

| CODE | GLASSES broj stakala | DESCRIPTION - OPIS           | PRICE CENA |
|------|----------------------|------------------------------|------------|
| I362 |                      | BLIND / PLEIN                | 290 €      |
| I363 | 1                    | GLASS / VITRAGE SANDBLAST    | 370 €      |
| I363 | 1                    | GLASS / VITRAGE CATHEDRAL    | 335 €      |
| I363 | 1                    | GLASS / VITRAGE SUPER SILVER | 408 €      |



DECORATIVE INOX SAFETY  
DEKORATIVNI INOX DETALJI

80 €

| CODE | GLASSES broj stakala | DESCRIPTION - OPIS        | PRICE CENA |
|------|----------------------|---------------------------|------------|
| I345 |                      | BLIND / PLEIN             | 290 €      |
| I346 | 4                    | TZAMIA BR                 | 400 €      |
| I346 | 4                    | GLASS / VITRAGE FUSED     | 560 €      |
| I346 | 4                    | GLASS / VITRAGE CATHEDRAL | 390 €      |



| CODE | GLASSES broj stakala | DESCRIPTION - OPIS        | PRICE CENA |
|------|----------------------|---------------------------|------------|
| I372 |                      | BLIND / PLEIN             | 290 €      |
| I373 | 1                    | GLASS / VITRAGE CATHEDRAL | 335 €      |
| I373 | 1                    | GLASS / VITRAGE FUSED     | 415 €      |



DECORATIVE INOX SAFETY  
DEKORATIVNI INOX DETALJI

80 €

| CODE | GLASSES broj stakala | DESCRIPTION - OPIS           | PRICE CENA |
|------|----------------------|------------------------------|------------|
| I347 |                      | BLIND / PLEIN                | 510 €      |
| I348 | 1                    | GLASS / VITRAGE SANDBLAST    | 615 €      |
| I348 | 1                    | GLASS / VITRAGE CATHEDRAL    | 590 €      |
| I348 | 1                    | GLASS / VITRAGE SUPER SILVER | 652 €      |



| CODE | GLASSES broj stakala | DESCRIPTION - OPIS        | PRICE CENA |
|------|----------------------|---------------------------|------------|
| I375 |                      | BLIND / PLEIN             | 290 €      |
| I376 | 5                    | GLASS / VITRAGE CATHEDRAL | 390 €      |
| I376 | 5                    | GLASS / VITRAGE FUSED     | 485 €      |



DECORATIVE INOX SAFETY  
DEKORATIVNI INOX DETALJI

100 €

| CODE | GLASSES broj stakala | DESCRIPTION - OPIS        | PRICE CENA |
|------|----------------------|---------------------------|------------|
| I350 |                      | BLIND / PLEIN             | 290 €      |
| I351 | 1                    | GLASS / VITRAGE CATHEDRAL | 335 €      |
| I351 | 1                    | GLASS / VITRAGE FUSED     | 445 €      |
| I352 | 2                    | GLASS / VITRAGE CATHEDRAL | 375 €      |
| I352 | 2                    | GLASS / VITRAGE FUSED     | 560 €      |
| I354 | 4                    | GLASS / VITRAGE CATHEDRAL | 415 €      |
| I354 | 4                    | GLASS / VITRAGE FUSED     | 685 €      |



| CODE | GLASSES broj stakala | DESCRIPTION - OPIS           | PRICE CENA |
|------|----------------------|------------------------------|------------|
| I378 |                      | BLIND / PLEIN                | 475 €      |
| I379 | 1                    | GLASS / VITRAGE CATHEDRAL    | 520 €      |
| I379 | 1                    | GLASS / VITRAGE SANDBLAST    | 530 €      |
| I379 | 1                    | GLASS / VITRAGE SUPER SILVER | 577 €      |



| CODE | GLASSES broj stakala | DESCRIPTION - OPIS | PRICE CENA |
|------|----------------------|--------------------|------------|
| I357 |                      | BLIND              | 290 €      |



| CODE | GLASSES broj stakala | DESCRIPTION - OPIS           | PRICE CENA |
|------|----------------------|------------------------------|------------|
| I388 |                      | BLIND / PLEIN                | 380 €      |
| I389 | 1                    | GLASS / VITRAGE CATHEDRAL    | 375 €      |
| I389 | 1                    | GLASS / VITRAGE SANDBLAST    | 410 €      |
| I389 | 1                    | GLASS / VITRAGE SUPER SILVER | 443 €      |



BLIND / PLEIN= puna vrata  
TRANSOM = sa prečkama  
VITRO= bojeno staklo  
SAFETY= INOX detalji  
FUSED= izliveno  
DECO= dekorativno  
CATHEDRAL= katedral  
SANDBLAST= peskareno  
SUPER SILVER=sivi stopsol

For decorative panel with safety inox, add the letter "M" at the end of the code, i.e. I395M  
Za dekorativne INOX detalje, dodati slovo «M» na kraju šifre, npr. I395M

GLASS / STAKLO KATEDRAL: WHITE/BELO, RED/CRVENO, BLUE/PLAVO, YELLOW/ŽUTO  
GLASS / STAKLO: WHITE/BELO, RED/CRVENO, BLUE/PLAVO

| CODE | GLASSES broj stakala | DESCRIPTION - OPIS    | PRICE CENA |
|------|----------------------|-----------------------|------------|
| I400 |                      | BLIND / PLEIN         | 360 €      |
| I401 | 1                    | GLASS / VITRAGE FUSED | 490 €      |
| I402 | 2                    | GLASS / VITRAGE FUSED | 535 €      |
| I403 | 3                    | GLASS / VITRAGE FUSED | 575 €      |



| CODE | GLASSES broj stakala | DESCRIPTION - OPIS        | PRICE CENA |
|------|----------------------|---------------------------|------------|
| I380 |                      | BLIND / PLEIN             | 290 €      |
| I382 | 2                    | GLASS / VITRAGE CATHEDRAL | 390 €      |
| I382 | 2                    | GLASS / VITRAGE FUSED     | 560 €      |

DECORATIVE INOX SAFETY  
DEKORATIVNE INOX APLIKACIJE

100 €

| CODE | GLASSES broj stakala | DESCRIPTION - OPIS    | PRICE CENA |
|------|----------------------|-----------------------|------------|
| I405 |                      | BLIND / PLEIN         | 320 €      |
| I406 | 1                    | GLASS / VITRAGE FUSED | 500 €      |



| CODE | GLASSES broj stakala | DESCRIPTION - OPIS           | PRICE CENA |
|------|----------------------|------------------------------|------------|
| I385 |                      | BLIND / PLEIN                | 290 €      |
| I386 | 1                    | GLASS / VITRAGE FUSED        | 475 €      |
| I386 | 1                    | GLASS / VITRAGE SANDBLAST    | 365 €      |
| I386 | 1                    | GLASS / VITRAGE SUPER SILVER | 388 €      |
| I387 | 4                    | GLASS / VITRAGE FUSED        | 535 €      |
| I387 | 4                    | GLASS / VITRAGE SANDBLAST    | 385 €      |
| I387 | 4                    | GLASS / VITRAGE SUPER SILVER | 422 €      |

| CODE | GLASSES broj stakala | DESCRIPTION - OPIS | PRICE CENA |
|------|----------------------|--------------------|------------|
| I410 |                      | BLIND              | 320 €      |
| I411 | 1                    | GLASS              | 480 €      |



| CODE | GLASSES broj stakala | DESCRIPTION - OPIS        | PRICE CENA |
|------|----------------------|---------------------------|------------|
| I392 |                      | BLIND / PLEIN             | 290 €      |
| I393 | 1                    | GLASS / VITRAGE CATHEDRAL | 335 €      |
| I394 | 2                    | GLASS / VITRAGE CATHEDRAL | 380 €      |
| I395 | 3                    | GLASS / VITRAGE CATHEDRAL | 410 €      |
| I395 | 3                    | GLASS / VITRAGE FUSED     | 560 €      |

DECORATIVE INOX SAFETY  
DEKORATIVNE INOX APLIKACIJE

80 €

| CODE | GLASSES broj stakala | DESCRIPTION - OPIS    | PRICE CENA |
|------|----------------------|-----------------------|------------|
| I415 |                      | BLIND / PLEIN         | 325 €      |
| I416 | 1                    | GLASS / VITRAGE FUSED | 510 €      |



| CODE | GLASSES broj stakala | DESCRIPTION - OPIS        | PRICE CENA |
|------|----------------------|---------------------------|------------|
| I367 |                      | BLIND / PLEIN             | 200 €      |
| I368 | 1                    | GLASS / VITRAGE CATHEDRAL | 230 €      |
| I368 | 1                    | GLASS / VITRAGE FUSED     | 250 €      |
| I369 | 3                    | GLASS / VITRAGE CATHEDRAL | 280 €      |
| I369 | 3                    | GLASS / VITRAGE FUSED     | 430 €      |

DECORATIVE INOX SAFETY  
DEKORATIVNE INOX APLIKACIJE

80 €

| CODE | GLASSES broj stakala | DESCRIPTION - OPIS | PRICE CENA |
|------|----------------------|--------------------|------------|
| I417 |                      | BLIND / PLEIN      | 380 €      |



| CODE | GLASSES broj stakala | DESCRIPTION - OPIS    | PRICE CENA |
|------|----------------------|-----------------------|------------|
| I396 |                      | BLIND / PLEIN         | 290 €      |
| I397 | 1                    | GLASS / VITRAGE FUSED | 505 €      |
| I398 | 2                    | GLASS / VITRAGE FUSED | 710 €      |

BLIND / PLEIN= puna vrata  
TRANSOM = sa prečkama  
VITRO= bojeno staklo  
SAFETY= INOX detalji  
FUSED= izliveno  
DECO= dekorativno  
CATHEDRAL= katedral  
SANDBLAST= peskareno  
SUPER SILVER=sivi stopsol

# E2000 Series | Flexible

- Modern design
- Wide selection of glasses
- Double glazing
- Fused glazing with Inox for extra resistance and high aesthetics\*
- Cast aluminium security for extra protection
- Multiple design option
- Certified powder coatings and wood imitation shades

- Moderan dizajn
- Veliki izbor stakala
- Dvostruko staklo
- Fuziono staklo sa INOX detaljima za posebnu otpornost sa izuzetnim estetskim efektom\*
- Specijalno obrađen aluminijum za dodatnu zaštitu
- Mogućnost kombinovanja različitih elemenata
- Sertifikovane boje za panele i folije u drvo dezenu

|   |
|---|
| DEBLJINA AL LIMA<br>ALUMINIUM SHEET THICKNESS   |
| 1 mm  |
| UKUPNA DEBLJINA PANELE<br>TOTAL PANEL THICKNESS   |
| 23 mm   |
| RAZDVAJANJE UKRASNE LAJSNE<br>OD POVRŠINE PANELE<br>FRAME DETACHMENT FROM PANEL<br>SURFACE                        |
| 50,02 Pa/mm <sup>2</sup>  |
| RAZDVAJANJE ALUMINIJUMSKOG LIMA<br>OD TERMOIZOLACIONOG MATERIJALA<br>SHEET DETACHMENT FROM<br>INSULATION MATERIAL |
| 0,488 N/mm <sup>2</sup>   |
| KOEFICIJENAT TOPLOTNE OTPORNOSTI<br>THERMAL RESISTANCE COEFFICIENT  |
| $RD = m^2 * K/W = 0,55$   |
| KOEFICIJENAT TOPLOTNE<br>PROVODLJIVOSTI<br>THERMAL CONDUCTIVITY COEFFICIENT                                       |
| $\lambda d = W/M * K = 0,035$   |

\*Each FUSED glass is different due to its handmade special procedure so the original product can be partially varied from the catalogue's photo appearance.

\* Svako staklo je različito zahvaljujući specijalnoj ručnoj izradi, tako da izgled originalnog proizvoda može delimično da se razlikuje od onoga na slici

# E2000 Series



E780



E781



E782



E783



E785

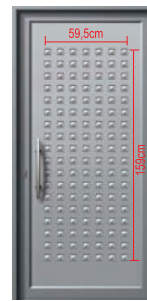

E789

| CODE | DESCRIPTION | PRICE<br>PRIX |
|------|-------------|---------------|
| E780 | BLIND       | 112€          |
| E781 | BLIND       | 112€          |
| E782 | BLIND       | 112€          |

| CODE | DESCRIPTION | PRICE<br>PRIX |
|------|-------------|---------------|
| E783 | BLIND       | 112 €         |
| E785 | BLIND       | 112 €         |
| E789 | BLIND       | 112 €         |



E714



E784

| CODE | DESCRIPTION | PRICE<br>PRIX |
|------|-------------|---------------|
| E784 | BLIND       | 112 €         |
| E714 | BLIND       | 112 €         |

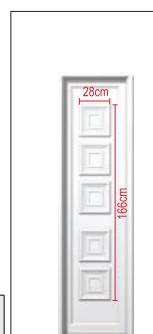

| CODE | GLASSES<br>VITRAGES | DESCRIPTION | PRICE<br>PRIX |
|------|---------------------|-------------|---------------|
| E520 |                     | BLIND       | 80 €          |
| E521 | 1                   | TRANSOM     | 96 €          |
| E521 | 1                   | SAFETY      | 116 €         |
| E522 | 2                   | TRANSOM     | 107 €         |
| E522 | 2                   | SAFETY      | 143 €         |
| E522 | 2                   | FUSED       | 153 €         |
| E523 | 3                   | TRANSOM     | 118 €         |
| E523 | 3                   | SAFETY      | 169 €         |
| E523 | 3                   | FUSED       | 167 €         |
| E526 | 5                   | TRANSOM     | 138 €         |
| E526 | 5                   | SAFETY      | 223 €         |
| E526 | 5                   | FUSED       | 210 €         |

| CODE | GLASSES<br>VITRAGES | DESCRIPTION | PRICE<br>PRIX |
|------|---------------------|-------------|---------------|
| E845 |                     | BLIND       | 112 €         |
| E846 | 1                   | TRANSOM     | 183 €         |
| E846 | 1                   | VITRO       | 253 €         |
| E846 | 1                   | FUSED       | 245 €         |
| E846 | 1                   | DECO        | 210 €         |
| E846 | 1                   | SAFETY      | 220 €         |



| CODE | GLASSES<br>VITRAGES | DESCRIPTION | PRICE<br>PRIX |
|------|---------------------|-------------|---------------|
| E820 |                     | BLIND       | 112 €         |
| E822 | 2                   | TRANSOM     | 165 €         |
| E822 | 2                   | SAFETY      | 201 €         |
| E822 | 2                   | FUSED       | 200 €         |
| E824 | 4                   | TRANSOM     | 183 €         |
| E824 | 4                   | SAFETY      | 232 €         |
| E826 | 6                   | TRANSOM     | 205 €         |
| E826 | 6                   | SAFETY      | 263 €         |
| E826 | 6                   | FUSED       | 333 €         |
| E829 | 10                  | TRANSOM     | 241 €         |
| E829 | 10                  | SAFETY      | 325 €         |
| E829 | 10                  | FUSED       | 453 €         |



BLIND = puna vrata  
 TRANSOM = sa prečkama  
 VITRO= bojeno staklo  
 SAFETY= INOX detalji  
 FUSED= izliveno  
 DECO= dekorativno  
 EXTRA CHARGES PER GLASS=  
 dodatna naplata po staklu

Aluglobe  
 katalog sa  
 cenovnikom  
 2013

76

# AluGlobe.

For decorative panel with safety inox, add the letter "M" at the end of the code, i.e. I395M  
 Za dekorativne inox detalje, dodati slovo "M" na kraju šifre, npr. I395M



| CODE | GLASSES broj stakala | DESCRIPTION - OPIS    | PRICE CENA |
|------|----------------------|-----------------------|------------|
| E856 |                      | BLIND / PLEIN         | 80 €       |
| E857 | 1                    | TRANSOM / PETITS BOIS | 98 €       |
| E857 | 1                    | FUSED                 | 133 €      |
| E857 | 1                    | VITRO                 | 134 €      |
| E857 | 1                    | DECO                  | 116 €      |
| E858 | 2                    | TRANSOM / PETITS BOIS | 116 €      |
| E858 | 2                    | FUSED                 | 196 €      |
| E858 | 2                    | VITRO                 | 197 €      |
| E858 | 2                    | DECO                  | 163 €      |
| E859 | 3                    | TRANSOM / PETITS BOIS | 129 €      |
| E859 | 3                    | FUSED                 | 249 €      |
| E859 | 3                    | VITRO                 | 250 €      |
| E859 | 3                    | DECO                  | 207 €      |



| CODE | GLASSES broj stakala | DESCRIPTION - OPIS | PRICE CENA |
|------|----------------------|--------------------|------------|
| E586 |                      | BLIND              | 112 €      |
| E587 | 1                    | TRANSOM            | 183 €      |



| CODE | GLASSES broj stakala | DESCRIPTION - OPIS    | PRICE CENA |
|------|----------------------|-----------------------|------------|
| E556 |                      | BLIND / PLEIN         | 112 €      |
| E557 | 1                    | TRANSOM / PETITS BOIS | 143 €      |
| E557 | 1                    | SAFETY                | 210 €      |
| E557 | 1                    | FUSED                 | 223 €      |
| E557 | 1                    | VITRO                 | 240 €      |
| E557 | 1                    | DECO                  | 213 €      |
| E558 | 3                    | TRANSOM / PETITS BOIS | 174 €      |
| E558 | 3                    | DECO                  | 270 €      |
| E559 | 5                    | TRANSOM / PETITS BOIS | 201 €      |
| E559 | 5                    | FUSED                 | 397 €      |
| E559 | 5                    | VITRO                 | 460 €      |
| E559 | 5                    | DECO                  | 333 €      |



| CODE | GLASSES broj stakala | DESCRIPTION - OPIS    | PRICE CENA |
|------|----------------------|-----------------------|------------|
| E536 |                      | BLIND / PLEIN         | 112 €      |
| E537 | 4                    | TRANSOM / PETITS BOIS | 201 €      |
| E537 | 4                    | SAFETY                | 303 €      |
| E537 | 4                    | FUSED                 | 330 €      |



| CODE | GLASSES broj stakala | DESCRIPTION - OPIS    | PRICE CENA |
|------|----------------------|-----------------------|------------|
| E725 |                      | BLIND / PLEIN         | 112 €      |
| E726 | 1                    | TRANSOM / PETITS BOIS | 143 €      |
| E726 | 1                    | SAFETY                | 210 €      |
| E726 | 1                    | FUSED                 | 223 €      |
| E726 | 1                    | DECO                  | 213 €      |
| E727 | 2                    | TRANSOM / PETITS BOIS | 214 €      |
| E727 | 2                    | FUSED                 | 313 €      |
| E727 | 2                    | SAFETY                | 270 €      |



| CODE | GLASSES broj stakala | DESCRIPTION - OPIS    | PRICE CENA |
|------|----------------------|-----------------------|------------|
| E760 |                      | BLIND / PLEIN         | 112 €      |
| E761 | 1                    | TRANSOM / PETITS BOIS | 187 €      |
| E761 | 1                    | SAFETY                | 267 €      |



| CODE | GLASSES broj stakala | DESCRIPTION - OPIS    | PRICE CENA |
|------|----------------------|-----------------------|------------|
| E860 |                      | BLIND / PLEIN         | 112 €      |
| E862 | 2                    | TRANSOM / PETITS BOIS | 196 €      |
| E862 | 2                    | SAFETY                | 220 €      |
| E864 | 4                    | TRANSOM / PETITS BOIS | 223 €      |
| E864 | 4                    | SAFETY                | 270 €      |



| CODE | GLASSES broj stakala | DESCRIPTION - OPIS    | PRICE CENA |
|------|----------------------|-----------------------|------------|
| E547 |                      | BLIND / PLEIN         | 112 €      |
| E548 | 2                    | TRANSOM / PETITS BOIS | 191 €      |
| E549 | 4                    | TRANSOM / PETITS BOIS | 236 €      |

BLIND / PLEIN= puna vrata  
 TRANSOM = sa prečkama  
 VITRO= bojeno staklo  
 SAFETY= INOX detalji  
 FUSED= izliveno  
 DECO= dekorativno  
 EXTRA CHARGES PER GLASS=  
 dodatna naplata po staklu

# E2000 Series

| CODE   | GLASSES | DESCRIPTION           | PRICE |
|--------|---------|-----------------------|-------|
| E854 L |         | BLIND / PLEIN         | 80 €  |
| E855 L | 1       | TRANSOM / PETITS BOIS | 103 € |
| E855 L | 1       | DECO                  | 123 € |
| E868 L | 2       | TRANSOM / PETITS BOIS | 140 € |



E854L E854R



| CODE | GLASSES | DESCRIPTION                 | PRICE |
|------|---------|-----------------------------|-------|
| E850 |         | BLIND / PLEIN               | 112 € |
| E851 | 1       | TRANSOM / PETITS BOIS       | 158 € |
| E851 | 1       | SAFETY / GRILLE DE SÉCURITÉ | 205 € |
| E851 | 1       | DECO                        | 213 € |
| E853 | 3       | TRANSOM / PETITS BOIS       | 233 € |

| CODE | GLASSES | DESCRIPTION                 | PRICE |
|------|---------|-----------------------------|-------|
| E870 |         | BLIND / PLEIN               | 112 € |
| E871 | 1       | TRANSOM / PETITS BOIS       | 196 € |
| E871 | 1       | SAFETY / GRILLE DE SÉCURITÉ | 259 € |
| E871 | 1       | DECO                        | 277 € |



| CODE | GLASSES | DESCRIPTION           | PRICE |
|------|---------|-----------------------|-------|
| E897 |         | BLIND / PLEIN         | 112 € |
| E898 | 2       | TRANSOM / PETITS BOIS | 183 € |

| CODE | GLASSES | DESCRIPTION           | PRICE |
|------|---------|-----------------------|-------|
| E895 |         | BLIND / PLEIN         | 112 € |
| E896 | 2       | TRANSOM / PETITS BOIS | 191 € |
| E896 | 2       | FUSED                 | 334 € |
| E899 | 4       | TRANSOM / PETITS BOIS | 249 € |
| E899 | 4       | FUSED                 | 400 € |



| CODE | GLASSES | DESCRIPTION           | PRICE |
|------|---------|-----------------------|-------|
| E892 |         | BLIND / PLEIN         | 80 €  |
| E893 | 1       | TRANSOM / PETITS BOIS | 107 € |
| E893 | 1       | FUSED                 | 178 € |
| E894 | 2       | TRANSOM / PETITS BOIS | 127 € |
| E894 | 2       | FUSED                 | 240 € |

| CODE | GLASSES VITRAGES | DESCRIPTION           | PRICE PRIX |
|------|------------------|-----------------------|------------|
| E951 |                  | BLIND / PLEIN         | 112 €      |
| E952 | 2                | TRANSOM / PETITS BOIS | 178 €      |
| E952 | 2                | FUSED                 | 280 €      |
| E952 | 2                | DECO                  | 214 €      |
| E954 | 4                | TRANSOM / PETITS BOIS | 227 €      |
| E954 | 4                | FUSED                 | 373 €      |
| E954 | 4                | DECO                  | 280 €      |



| CODE  | GLASSES VITRAGES | DESCRIPTION                 | PRICE PRIX |
|-------|------------------|-----------------------------|------------|
| P6150 |                  | BLIND / PLEIN               | 170 €      |
| P6151 | 1                | TRANSOM / PETITS BOIS       | 235 €      |
| P6151 | 1                | SAFETY / GRILLE DE SECURITE | 280 €      |
| P6151 | 1                | VITRO                       | 320 €      |
| P6152 | 2                | TRANSOM / PETITS BOIS       | 260 €      |
| P6152 | 2                | SAFETY / GRILLE DE SECURITE | 320 €      |
| P6152 | 2                | VITRO                       | 395 €      |
| P6153 | 3                | TRANSOM / PETITS BOIS       | 285 €      |
| P6153 | 3                | SAFETY / GRILLE DE SECURITE | 385 €      |
| P6153 | 3                | VITRO                       | 470 €      |

AluGlobe

Aluglobe  
katalog sa  
cenovnikom  
2013

78

For decorative panel with safety inox, add the letter "M" at the end of the code, i.e. I395M  
Za dekorativne inox detalje, dodati slovo "M" na kraju šifre, npr. I395M

BLIND / PLEIN= puna vrata  
TRANSOM = sa prečkama  
VITRO= bojeno staklo  
SAFETY= INOX detalji  
FUSED= izliveno  
DECO= dekorativno  
EXTRA CHARGES PER GLASS=  
dodatna naplata po staklu

TRIPLEX  
EXTRA CHARGES PER GLASS 15 €

# entrancesuite

## Nova serija panela za ulazna vrata.

Premium serija koja pruža maksimalnu termo i zvučnu izolaciju, kao i neprobojnost.

Novi termoizolacioni ulazni sistem ALUMINCO, se izrađuje u više varijanti. Najnovija tehnologija pri načinu izrade garantuje visoki kvalitet i funkcionalnost kao i uštedu energije, tako da ispunjava svaki arhitektonski zahtev. Ovakve performanse najnovije serije panela, ostavljaju i savršen estetski rezultat jer je dizajnu posvećena posebna pažnja. Posebno izdvajamo ravne i čiste površine sistema, a izbegnuti su glomazni profili koji se koriste u običnim sistemima.

Zbog upotrebe specijalnih poliamida od 30mm, moguće je koristiti ih u konstrukcijama velikih otvora.

### Tehničke karakteristike

|                           |      |
|---------------------------|------|
| Širina krila              | 95mm |
| Širina najmanjeg štoka    | 95mm |
| Panel                     | 42mm |
| Poliamid nemačkog porekla | 30mm |

### Svojstva sistema

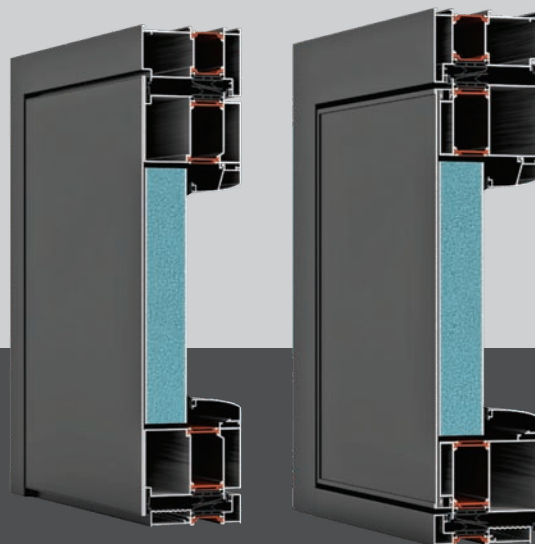

AL 600

AL 590

Aluglobe  
katalog sa  
cenovnikom  
2013





680 €

7251



1230 €

7410



920 €

7330



440 €

7116



580 €

7811



470 €

7325



630 €

7225



480 €

7616



390 €

7121



670 €

7626

# entrancesuite



840 €

7216



750 €

7241



990 €

7336



760 €

7621

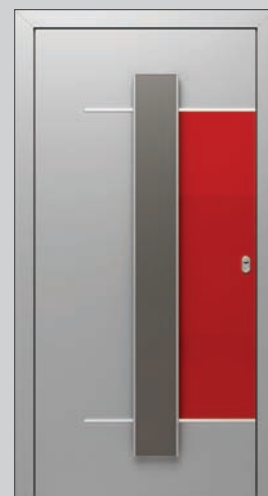

520 €

7310



690 €

7210



650 €

7246



810 €

7341



870 €

7346



770 €

7711



480 €

7510



1040 €

7911



720 €

7231



610 €

7320



780 €

7316



750 €

7611



390 €

7110



670 €

7236



610 €

7256



680 €

7221

# firedoors protivpožarnavrata

Anti panik brave



Mogućnost oblaganja  
vrata štampanim termo folijama



# firedoors protivpožarnavrata

# firme doors protivpožarnavrata

REI 60 REI 90



dvokrilna

## Model: PROGET

**Tip: dvokrilna, debljine 60 mm, 90 minuta**

PROGET vrata, dvokrilna protivpožarna, REI90 minuta prema standardu UNI 9723, kompletno izrađena od galvanizovanog čeličnog lima. Rasklopljen 3-delni ram sa ankerima za fiksiranje u malter. Glavno krilo sa bravom za protivpožarna vrata, CE znak prema EN 12209 sa cilindrom i umetkom sa ključem. Podna kvaka od crne palstike.

Crna sigurnosna ručica sa čeličnim jezgrom, visina ose (osovine) od zemlje:

- 1050mm za sva vrata.

Drugo krilo sa centralnim stoperom i šipkama.

Četiri šarke: 1 šarka po krilu sa lagerom i

šrafovim za vertikalno podešavanje, 1 šarka sa samozatvarajućom oprugom po krilu. Sigurnosni zavrtanj na šarci na ivici krila. Unutrašnji umetak za panik bravu i gornju bravu. Regulator zatvaranja RC/STD. Samošireće ispune. Standardna obrada površine epoxz-poliester prahom, površina sa zaštitom od grebanja, narandžina kora.

Standardna boja svetlo pastelna tirkizna za krilo vrata (NCS4020-B50G), i tamnija nijansa za ram vrata (NCS5020- B50G). Na zahtev je moguće i farbanje po RAL-u. Vrata nemaju prag.

**NAVESTI SMER OTVARANJA PRILIKOM PORUDŽBINE.**

## PROGET protivpožarna vrata

dvokrilna vrata debljine 60mm, 90 minuta

| Širina | Visina | Cena  |
|--------|--------|-------|
| 800    | 2050   | 528 € |
| 900    | 2050   | 559 € |
| 1000   | 2050   | 584 € |
| 800    | 2150   | 551 € |
| 900    | 2150   | 578 € |
| 1000   | 2150   | 606 € |

EI<sub>2</sub>60 REI 60 REI 90



jednokrilna

## Model: UNIVER

**Tip: jednokrilna, debljine 60 mm, 90 minuta**

UNIVER vrata, jednokrilna protivpožarna, REI120 minuta prema standardu UNI 9723, kompletno izrađena od galvanizovanog čeličnog lima. Rasklopljen 4-delni ram sa ankerima za fiksiranje u malter ili sa produženim šrafovim (koje obezbeđuje kupac). Brava za protivpožarna vrata, CE znak prema EN 12209 sa cilindrom i umetkom sa ključem. Crna sigurnosna ručica sa čeličnim jezgrom, visina ose (osovine) od zemlje:

- za vrata sa H=2050 mm = 1075 mm

- za vrata sa H=2150 mm = 1125 mm

- za vrata sa H po meri = H/2+50 mm

Dve šarke: 1 šarka sa lagerom sa šrafovim za vertikalno podešavanje, 1 šarka sa samozatvarajućom oprugom. Sigurnosni zavrtanj na šarci na ivici krila. Unutrašnji umetak za panik bravu i gornju bravu. Samošireće ispune.

Standardna obrada površine epoxz-poliester prahom, površina sa zaštitom od grebanja, narandžina kora.

Standardna boja svetlo pastelna tirkizna za krilo vrata (NCS4020-B50G), i tamnija nijansa za ram vrata (NCS5020- B50G). Na zahtev je moguće i farbanje po RAL-u.

## UNIVER protivpožarna vrata

debljina 60mm, 90 minuta

| Širina | Visina | Cena  |
|--------|--------|-------|
| 800    | 2050   | 192 € |
| 900    | 2050   | 199 € |
| 1000   | 2050   | 209 € |
| 800    | 2150   | 198 € |
| 900    | 2150   | 208 € |
| 1000   | 2150   | 217 € |

Mogućnost izrade svih nestandardnih dimenzija protivpožarnih vrata prema zahtevu kupca sa rokom isporuke od 15 do 45 dana.

Cene su bez PDV-a

# Proget

Aluglobe  
katalog sa  
cenovnikom  
2013

84

# univer

# multipurpose doors

## PEŠAČKA METALNA VRATA

Model: REVER

Tip: jednokrilna, debljine 40 mm

REVER višenamenska jednokrilna vrata, kompletno izrađena od galvanizovanog čeličnog lima. Ispuna od kartona u obliku saća i sklopljen 4-delni ram sa sa ankerima za fiksiranje u malter ili sa produženim šrafovim (koje obezbeđuje kupac). Brava sa cilindrom i umetkom sa ključem. Crna sigurnosna ručica sa čeličnim jezgrom, visina ose (osovine) od zemlje:

-za vrata sa H=2050 mm = 1075 mm

-za vrata sa H=2150 mm = 1125 mm

-za vrata sa H po meri = H/2+50 mm

Dve šarke sa lagerom i 3 sigurnosna šrafa na strani šarki. Standardna obrada površine epoxy-poliester prahom, površina sa zaštitom od grebanja, narandžina kora. Standardna boja svetlo pastelna tirkizna za krilo vrata (NCS4020-B50G), i tamnija nijansa za ram vrata (NCS5020-B50G). Na zahtev je moguće i farbanje po RAL-u ili dekorativni NDD Ninc digitalni dekor. Reverzibilna vrata (mogu se okrenuti) sa ramom na podu koji je prilagodljiv završenom podu ili odvojiv i pripremljen za ugradnju sa sigurnosnom opremom.

U porudžbini navesti način otvaranja:

- a) vrata sa panik bravom SLASH
- b) vrata sa prozorom
- c) vrata sa MAC bravom
- d) vrata sa električnom ručicom ELM/mt – ELM/cisa
- e) vrata sa specijalnim bravama (016tir- Stel15ecc)
- f) vrata sa specijalnim ramom (speed-solid-tescop)

*Ukoliko ne naglasite smer otvaranja, vrata pod a) će biti isporučena sa otvaranjem na desno (DX)*



| ŠIRINA | VISINA | CENA  |
|--------|--------|-------|
| 800    | 2050   | 98 €  |
| 900    | 2050   | 102 € |
| 1000   | 2050   | 107 € |
| 800    | 2150   | 101 € |
| 900    | 2150   | 106 € |
| 1000   | 2150   | 109 € |

višenamenska metalna vrata

multipurpose doors

Cene su bez PDV-a

Aluglobe  
katalog sa  
cenovnikom  
2013

85

# Photovoltaic panels with support systems for flat roofs, inclined roofs and open areas

Fotonaponski paneli sa podkonstrukcijom na ravnim i kosim krovovima i otvorenim poljima



## ALUMINCO<sup>®</sup>

**A ALUMINIUM BUILDING SYSTEMS**

*supporting what you love*



Aluglobe  
katalog sa  
cenovnikom  
2013

86

# ELECTRA II

ALUMINCO<sup>®</sup>  
ALUMINIUM BUILDING SYSTEMS

Support system for solar panels on flat roofs  
Podkonstrukcija za solarne panele na ravnim krovovima

New/Novo

 System ELECTRA II was adjusted in order to be compatible for installation on flat roofs. It is designed in such way so it would support polycrystalline, monocrystalline as well as thin film photovoltaic panels and it is delivered as separate aluminum profiles and accessories or as a compound installation, already cut and drilled according to the dimensions of the solar panels and needs of each project.

System ELECTRA II has been designed in a way so it is possible either to be fixated on the roof of the building or it can be supported by the parapet of the roof with the use of a specially designed accessory.

The system is constructed to support solar panels in a certain angle, which is between 15°-45°.

The system has features that increase the ease in which it is assembled by using a special aluminum nut. This nut can be imported in any position of the profile without the need of sliding it in from the edge of the profile. In order for the system to be assembled, only vertical cuts and punctures are needed, without the need of using specialized tools. So every constructor has the ability to assemble the system no matter the size of the project with low costs.

 ELECTRA II sistem, je prilagođen da bi bio kompatibilan za instaliranje na ravnim krovovima. Dizajniran je da podržava polikristalne, monokristalne i tanke fotonaponske panele i može se isporučiti kao zasebni aluminijumski profil sa pratećom opremom ili kao gotov proizvod, sečen i bušen po dimenzijama solarnih panela i po potrebama svakog projekta.

ELECTRA II sistem, je dizajniran na takav način da se može fiksirati na krovu zgrade ili da se fiksira na parapet krova sa upotrebom specijalno dizajniranom pratećom opremom.

Sistem je konstruisan za solarne panele pod određenim uglom, između 15°-45°.

Karakteristike sistema povećavaju jednostavnost montiranja, pomoću specijalne aluminijumske matice. Matica može da se postavi u bilo kojem položaju profila bez potrebe za postavljanjem sa kraja profila. Kako bi se sistem montirao, potrebne su samo vertikalne obrade, bez upotrebe specijalnog alata. Što znači da svaki konstruktor ima mogućnost da montira sistem sa malim troškom, bez obzira na veličinu projekta.

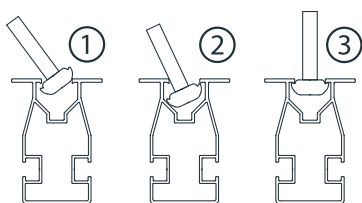

Ways of inserting aluminum nut in the profile

Način postavljanja Al. matice u profil



Horizontal layout 1x4 panels in a row  
Horizontalni presek 1x4 panela u redu

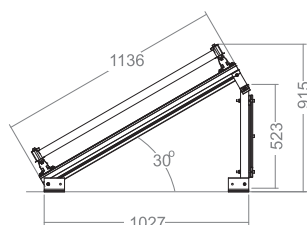

Side view of a triangle in 1 Landscape layout  
Bočni presek fotonaponskog panela

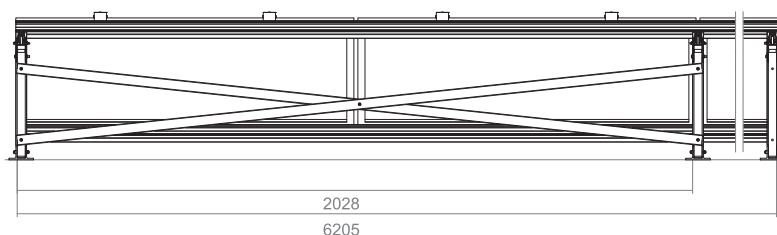

Back view of a triangle in 1 Landscape layout  
Presek zadnjeg dela fotonaponskog panela

Support systems for photovoltaic panels / Podkonstrukcija za fotonaponske panele

Aluglobe  
katalog sa  
cenovnikom  
2013



# ELECTRA II



Support system for solar panels on flat roofs  
Podkonstrukcija za solarne panele na ravnim krovovima



Vertical layout 2x6 panels in a row  
Vertikalni plan 2x6 panela u nizu

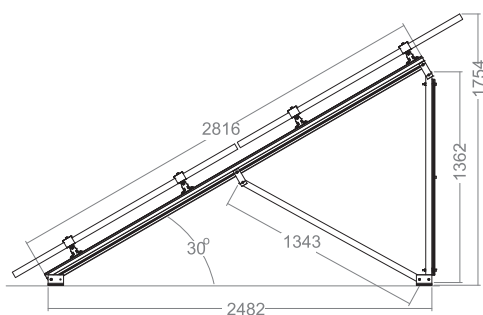

Side view of a triangle in 2 Portrait layout  
Bočni presek fotonaponskog panela

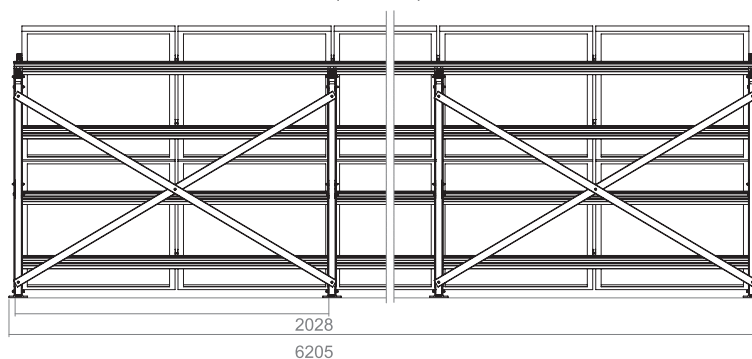

Back view of a triangle in 2 Portrait layout  
Presek zadnjeg dela fotonaponskih panela

Typical features of ELECTRA II layout / ELECTRA II tipične karakteristike

| Panel Layout<br>Plan panela | No of Panels<br>Broj panela | No of Triangles<br>Broj uglova> | Triangles' Distances<br>Udaljenost uglova | Systems' Weight<br>Težina sistema |
|-----------------------------|-----------------------------|---------------------------------|---|-----------------------------------|
| 1 Landscape / Plan 1        | 4                           | 3                               | 3322 mm                                   | 31 kg                             |
| 2 Landscape / Plan 2        | 8                           | 4                               | 2215 mm                                   | 54 kg                             |
| 1 Portrait / Portre 1       | 6                           | 4                               | 2028 mm                                   | 33 kg                             |
| 2 Portrait / Portre 2       | 12                          | 4                               | 2028 mm                                   | 66 kg                             |

# ESTIA

Support systems for PV panels on roofs with ceramic tiles  
Podkonstrukcija za PV panele na krovovima sa crepom

 Sistem ESTIA, za krovove sa crepom uključuje i inovativnu soluciju od ALUMINCO sa aluminijumskim crepom, koji je regulisan medjunarodnim pravom za patente, i obezbedjuje odličnu vodo zaptivenost bez mogućnosti ulaska vode u kuću. ESTIA sistem se montira korišćenjem aluminijumskih profila u oba horizontalna i vertikalna pravca koji osigurava da fotonaponski paneli imaju određenu udaljenost od krova zbog adekvatne ventilacije.

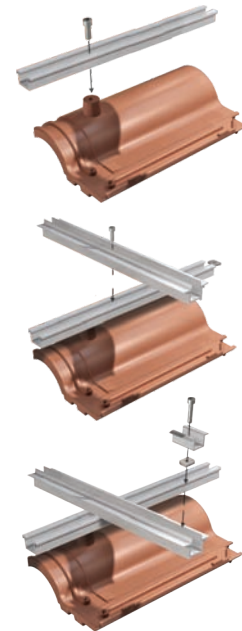
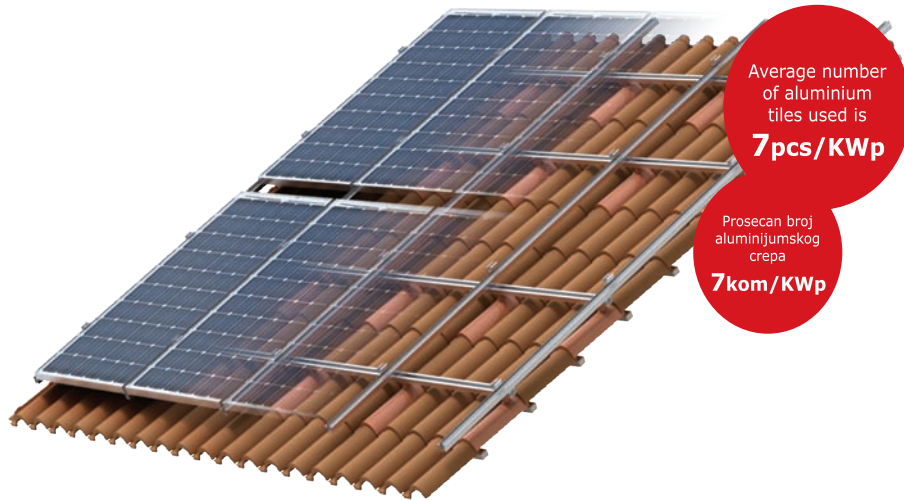

Aluminium roof tile

Installation steps for a double layout aluminium roof tile  
Montiranje duple vertikalne sa aluminijumskim crepom

 ALUMINCO inovativni aluminijumski crep je dizajniran da pruža bezbednost, brzinu i jednostavnu montažu. Izbegavajući bušenje crepa, ovo rešenje pruža odličnu vodo zaptivenost za celu konstrukciju. Aluminijumski crep je dostupan u 4 različita tipa - Rimski, Holandski, Francuski i Švedski. Ovo omogućava kompatibilnost sa svim standardnim tipovima crepa na tržištu, i zaštićen je medjunarodnim pravom za patente. Korišćenje aluminijumskog crepa pruža brzu montažu u poredjenju sa tradicionalnim metodama koje koriste metalne držače.



**INTERNATIONAL PATENT**

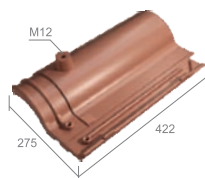

Roman type / Rimski

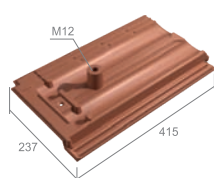

French type / Francuski

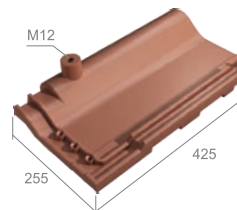

Dutch type / Holandski

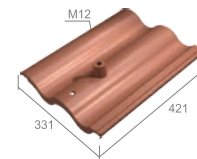

Swedish type / Švedski

# FAETHON II

Support system for solar parks (field installation)  
Podkonstrukcija za solarne parkove



System FAETHON II is used in open field solar installations. The modular philosophy of its construction provides an increased flexibility as far as the selection of the slope, the distance of the first solar panel from the ground and the number of solar panels that can be installed along the vertical axis is concerned. One of the biggest advantages of this system is the usage of a special aluminum nut. The nut can be inserted in any position on the profile without it have to be slid from the edge of the profile. The way the soles are installed, allows the absorption of any height differences that make happen by the way the system is grounded (earthscrews, poles with concrete bases etc.), between a width of 7 cm ( $\pm 3,5$  cm) on each sole. In order for the system to be assembled, only vertical cuts and punctures are needed, without the need of using specialized tools. So every constructor has the ability to assemble the system no matter the size of the project with low costs. The can assemble the triangles of the system in his own space, thus they can be ready for installing on the files, reducing the stay of the installers on sight to the minimum.



FAETHON II sistem se koristi za instaliranje na otvorenim poljima. Modularna filozofija ove konstrukcije pruža veću fleksibilnost kada je u pitanju izbor padine, rastojanje prvog solarnog panela od zemlje i broja solarnih panela koji se mogu instalirati duž vertikalne ose. Jedna od najvećih prednosti ovog sistema je upotreba specijalne aluminijumske matice. Matica se može ubaciti u bilo koju poziciju profila bez potrebe ubacivanja sa kraja profila. Način na koji su potpore instalirane, dozvoljava apsorpciju svih visinskih razlika koje se mogu desiti kada se sistem instalira na zemlji ( zemljani vijci, polovi sa konkretnim bazama itd.), sa širinom između 7 cm ( $\pm 3,5$  cm) svake potpore. Da bi se sistem montirao, potrebne su samo vertikalne obrade, bez potrebe za korišćenjem specijalnih alata. Što znači, da svaki konstruktor ima mogućnost da montira sistem bez obzira na veličinu projekta sa niskim troškovima. Mogu se montirati trouglovi sistema u radionici, tako da budu spremni za instaliranje na poljima, smanjujući boravak montažera na minimum.

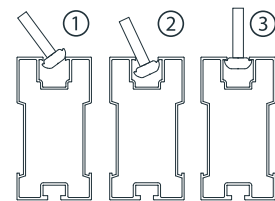

How to insert the nut in the profile  
Kako montirati maticu u profil

Horizontal layout 3x4 panels in a row  
Horizontalni plan 3x4 panela u nizu

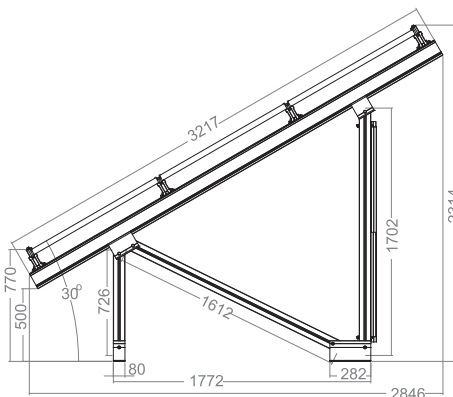

Side view of a triangle in 3 Landscape layout  
Bočni izgled fotonaponskih panela

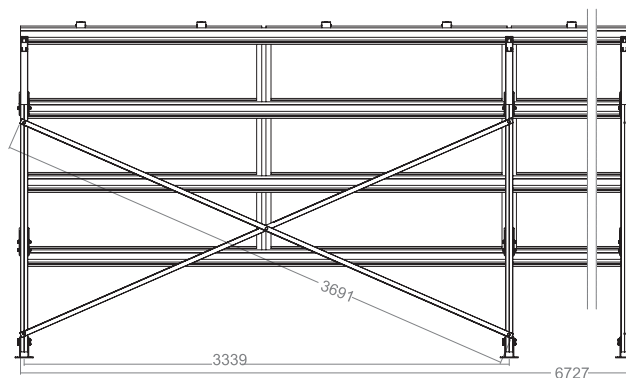

Back view of a triangle in 3 Landscape layout  
Izgled zadnjeg dela fotonaponskih panela

# FAETHON II



Support system for solar parks (field installation)  
Podkonstrukcija za solarne parkove



Horizontal layout 2x7 panels in a row  
Horizontalni plan 2x7 panela u nizu

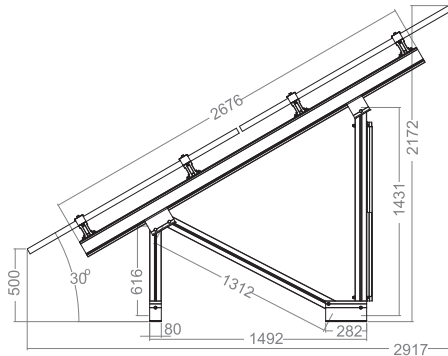

Side view of a triangle in 2 Portrait layout  
Bočni izgled fotonaponskih panela

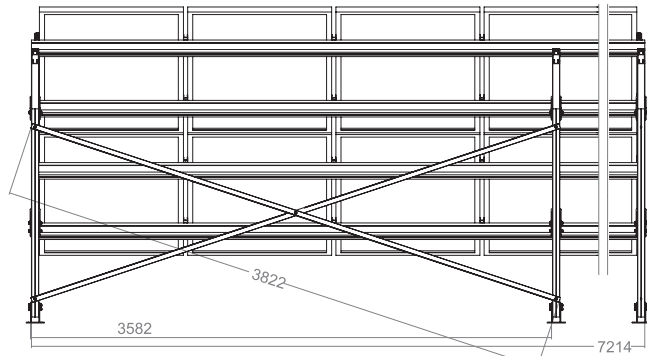

Back view of a triangle in 2 Portrait layout  
Izgled zadnjeg dela fotonaponskih panela



Horizontal layout 4x4 panels in a row  
Horizontalni plan 4x4 panela u nizu

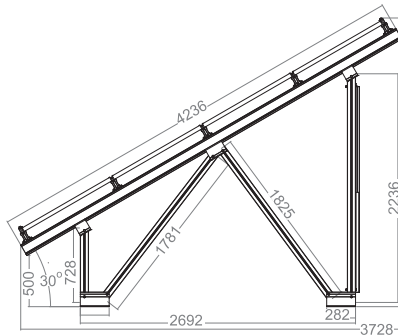

Side view of a triangle in 4 Landscape layout  
Bočni izgled fotonaponskih panela

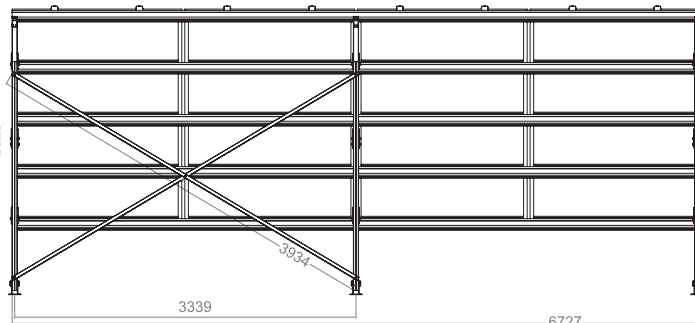

Back view of a triangle in 4 Landscape layout  
Izgled zadnjeg dela fotonaponskih panela

Aluglobe  
katalog sa  
cenovnikom  
2013

### FAPIM PROGRAM

| R.br | OPIS  | JM  | VP CENA |
|------|---|-----|---------|
| 1    | Šarka Venice (5601Ai)                               | kom | 7,235   |
| 2    | Rozetna cilindra (2100C)                            | kom | 0,729   |
| 3    | Horus kvaka za vrata (2051)                         | par | 7,205   |
| 4    | Set za okretno otvaranje sa ručicom (1978)          | set | 9,481   |
| 5    | Šarka blitz (9730)                                  | kom | 1,342   |
| 6    | Grip šarka crna                                     | kom | 3,034   |
| 7    | Stoper drugog krila za vrata - titan (3720C)        | kom | 5,601   |
| 8    | Makaza za ventus 150mm (3228I)                      | kom | 2,684   |
| 9    | Al.šnaper za prozor beli (3217)                     | kom | 3,442   |
| 10   | Okretno - nagibni okov G4 (set sa srednjom makazom) | set | 26,546  |

### ALUTECH PROGRAM

|    |  |     |       |
|----|--|-----|-------|
| 11 | WE110-AL okapnica 110mm - BELA 9016. BRAON 8014                              | m   | 2,720 |
| 12 | WE130-AL okapnica 130mm - BELA 9016. BRAON 8014                              | m   | 3,060 |
| 13 | WE150-AL okapnica 150mm - BELA 9016. BRAON 8014                              | m   | 3,400 |
| 14 | WE165-AL okapnica 165mm - BELA 9016. BRAON 8014. SIVA 9006                   | m   | 3,660 |
| 15 | WE180-AL okapnica 180mm - BELA 9016. BRAON 8014. SIVA 9006                   | m   | 3,880 |
| 16 | WE205-AL okapnica 205mm - BELA 9016. BRAON 8014. SIVA 9006                   | m   | 4,180 |
| 17 | WE225-AL okapnica 225mm - BELA 9016. BRAON 8014                              | m   | 4,510 |
| 18 | WE250-AL okapnica 250mm - BELA 9016. BRAON 8014                              | m   | 4,990 |
| 19 | WE280-AL okapnica 280mm - BELA 9016. BRAON 8014                              | m   | 5,540 |
| 20 | WE320-AL okapnica 320mm - BELA 9016. BRAON 8014                              | m   | 6,140 |
| 21 | WE360-AL okapnica 360mm - BELA 9016. BRAON 8014                              | m   | 6,770 |
| 22 | WE90-AL okapnica 90mm - BELA 9016. BRAON 8014                                | m   | 2,400 |
| 23 | Kapa leva/desna za okapnicu ALUTECH DO150 mm - 1 par BELA 9016. BRAON 8014   | kom | 0,310 |
| 24 | Kapa leva/desna za okapnicu ALUTECH 150-225mm - 1 par. BELA 9016. BRAON 8014 | kom | 0,350 |
| 25 | Kapa leva/desna za okapnicu ALUTECH 225-360mm - 1 par. BELA 9016. BRAON 8014 | kom | 0,510 |
| 26 | WS110-Čelična okapnica 110mm - BELA 9016. BRAON 8014                         | m   | 1,780 |
| 27 | WS130-Čelična okapnica 130mm - BELA 9016. BRAON 8014                         | m   | 1,990 |
| 28 | WS150-Čelična okapnica 150mm - BELA 9016. BRAON 8014                         | m   | 2,180 |
| 29 | WS165-Čelična okapnica 165mm - BELA 9016. BRAON 8014                         | m   | 2,350 |
| 30 | WS180-Čelična okapnica 180mm - BELA 9016. BRAON 8014                         | m   | 2,500 |
| 31 | WS205-Čelična okapnica 205mm - BELA 9016. BRAON 8014                         | m   | 2,760 |
| 32 | WS225-Čelična okapnica 225mm - BELA 9016. BRAON 8014                         | m   | 2,970 |
| 33 | WS250-Čelična okapnica 250mm - BELA 9016. BRAON 8014                         | m   | 3,260 |
| 34 | WS280-Čelična okapnica 280mm - BELA 9016. BRAON 8014                         | m   | 3,620 |
| 35 | WS320-Čelična okapnica 320mm - BELA 9016. BRAON 8014                         | m   | 4,060 |
| 36 | WS360-Čelična okapnica 360mm - BELA 9016. BRAON 8014                         | m   | 4,450 |
| 37 | WS90-Čelična okapnica 90mm - BELA 9016. BRAON 8014                           | m   | 1,566 |

\* NAPOMENA: ostale okapnice u bojama po RAL-u uz doplatu 20%.

### OSTALO

|    |  |     |       |
|----|--|-----|-------|
| 38 | Al lim u tabli 0,8x1000x2000mm                             | m2  | 12,48 |
| 39 | DOMUS 913575-Komplet brava 35mm, cilindar 75mm i šlic-pleh | kom | 11,31 |
| 40 | DOMUS 913575-Komplet brava 35mm, cilindar 83mm i šlic-pleh | kom | 11,92 |
| 41 | DOMUS 913575-Komplet brava 35mm, cilindar 90mm i šlic-pleh | kom | 12,6  |
| 42 | NUOVA FEB 7354 Brava sa tri bravljenja                     | kom | 39,69 |
| 43 | NUOVA FEB 683713-Set prihvatnih ploca trostepenu bravu     | kom | 7,984 |
| 44 | PVC PANEL 3000x2000mm (debljina 20mm ili 24mm)             | kom | 65,64 |
| 45 | Aluminijumski panel 20x2000x1000mm                         | kom | 40    |

\*\* NAPOMENA: U okviru ponude se nalaze i brojni aluminijumski trgovački profili.

VELEPRODAJNE CENE (VP) IZRAŽENE SU U EUR/JM, BEZ PDV-a i BEZ RABATA,  
PLAĆANJE SE VRŠI U DINARIMA PO SREDNJEM KURSU NARODNE BANKE SRBIJE

**ALUROLL**  
*...for smart people*

[www.aluglobe.com](http://www.aluglobe.com)  
[info@aluglobe.com](mailto:info@aluglobe.com)



sertifikovan sistem kvaliteta  
prema ISO 9001:2008  
standardu

TRGOVINSKO-PROIZVODNO d.o.o.  
Karadordeva 36, 34227 Batočina



PJ **AluGlobe**, Batajnički drum 6-O, 11080 Zemun  
Tel: 011/6555-685, 6555-686, Fax: 011/6555-688

Matični broj: 07626967, Poreski broj PIB: 101220521, Šifra delatnosti: 051700, Žiro račun: 265-3310310001439-08